



# User Guide for the SoundStation® IP 6000 Phone

SIP 3.0.2

April, 2008 Edition  
1725-15645-001 Rev. A  
SIP 3.0.2



---

## Trademark Information

Polycom®, the Polycom logo design, SoundPoint® IP, SoundStation®, SoundStation VTX 1000®, ViaVideo®, ViewStation®, and Vortex® are registered trademarks of Polycom, Inc. Conference Composer™, Global Management System™, ImageShare™, Instructor RP™, iPower™, MGC™, PathNavigator™, People+Content™, PowerCam™, Pro-Motion™, QSX™, ReadManager™, Siren™, StereoSurround™, V<sup>2</sup>IU™, Visual Concert™, VS4000™, VSX™, and the industrial design of SoundStation are trademarks of Polycom, Inc. in the United States and various other countries. All other trademarks are the property of their respective owners.

## Patent Information

The accompanying product is protected by one or more U.S. and foreign patents and/or pending patent applications held by Polycom, Inc.

## Disclaimer

Some countries, states, or provinces do not allow the exclusion or limitation of implied warranties or the limitation of incidental or consequential damages for certain products supplied to consumers, or the limitation of liability for personal injury, so the above limitations and exclusions may be limited in their application to you. When the implied warranties are not allowed to be excluded in their entirety, they will be limited to the duration of the applicable written warranty. This warranty gives you specific legal rights which may vary depending on local law.

## Copyright Notice

Portions of the software contained in this product are:

Copyright © 1998, 1999, 2000 Thai Open Source Software Center Ltd. and Clark Cooper

Copyright © 1998 by the Massachusetts Institute of Technology

Copyright © 1998-2003 The OpenSSL Project

Copyright © 1995-1998 Eric Young (eay@cryptsoft.com). All rights reserved

Copyright © 1995-2002 Jean-Loup Gailly and Mark Adler

Copyright © 1996-2004, Daniel Stenberg, <daniel@haxx.se>

Permission is hereby granted, free of charge, to any person obtaining a copy of this software and associated documentation files (the "Software"), to deal in the Software without restriction, including without limitation the rights to use, copy, modify, merge, publish, distribute, sublicense, and/or sell copies of the Software, and to permit persons to whom the Software is furnished to do so, subject to the following conditions:

The above copyright notice and this permission notice shall be included in all copies or substantial portions of the Software.

THE SOFTWARE IS PROVIDED "AS IS", WITHOUT WARRANTY OF ANY KIND, EXPRESS OR IMPLIED, INCLUDING BUT NOT LIMITED TO THE WARRANTIES OF MERCHANTABILITY, FITNESS FOR A PARTICULAR PURPOSE AND NONINFRINGEMENT. IN NO EVENT SHALL THE AUTHORS OR COPYRIGHT HOLDERS BE LIABLE FOR ANY CLAIM, DAMAGES OR OTHER LIABILITY, WHETHER IN AN ACTION OF CONTRACT, TORT OR OTHERWISE, ARISING FROM, OUT OF OR IN CONNECTION WITH THE SOFTWARE OR THE USE OR OTHER DEALINGS IN THE SOFTWARE.

© 2008 Polycom, Inc. All rights reserved.

Polycom Inc.  
4750 Willow Road  
Pleasanton, CA 94588-2708  
USA

No part of this document may be reproduced or transmitted in any form or by any means, electronic or mechanical, for any purpose, without the express written permission of Polycom, Inc. Under the law, reproducing includes translating into another language or format.

As between the parties, Polycom, Inc. retains title to, and ownership of, all proprietary rights with respect to the software contained within its products. The software is protected by United States copyright laws and international treaty provision. Therefore, you must treat the software like any other copyrighted material (e.g. a book or sound recording).

Every effort has been made to ensure that the information in this manual is accurate. Polycom, Inc. is not responsible for printing or clerical errors. Information in this document is subject to change without notice.

---

# About This Guide

Thank you for choosing the SoundStation® IP 6000 conference phone. This phone provides multi-person audio conferencing capabilities for medium to large conference rooms within a Session Initiation Protocol (SIP) internet telephony system.

This guide provides everything you need to quickly use your new phone. Verify with your system administrator that the network is prepared for configuring the phone. Also, read the Parts List and the Safety and Compliance section in this guide before you set up and use the phone.

This guide includes regulatory compliance information that your system administrator should review. You can also view this guide at [www.polycom.com/support/voip/](http://www.polycom.com/support/voip/).



# Contents

<b>About This Guide</b> .....	<b>iii</b>
<b>1 Getting Started with Your Phone</b> .....	<b>1-1</b>
Parts List .....	1-2
Optional Accessories .....	1-2
Installing the Phone .....	1-2
Connecting Network and Power Sources .....	1-3
Power over Ethernet .....	1-3
AC Power .....	1-4
Connecting Optional Extension Microphones .....	1-5
Features of the Phone .....	1-6
Understanding Line and Call Icons .....	1-9
Navigating Menus and Entering Data .....	1-10
<b>2 Customizing Your Phone</b> .....	<b>2-1</b>
Configuring Basic Settings .....	2-2
Updating Preferences .....	2-2
Updating the Language .....	2-2
Updating the Time and Date Display .....	2-3
Updating the Display Contrast .....	2-6
Updating the Backlight Intensity .....	2-6
Updating the Ring Tone .....	2-9
Selecting a Ring Tone .....	2-9
Setting Distinctive Ring Tones for Contacts .....	2-10
Adjusting the Speaker and Ringer Volume .....	2-11
Using Call Lists .....	2-11
Viewing Call Lists .....	2-11
Managing Call Lists .....	2-12
Managing Contacts .....	2-13
Adding Contacts to Your Local Contact Directory .....	2-14
Adding Contacts Manually .....	2-15
Adding Contacts From Call Lists .....	2-17
Adding Contacts to Your Contact Directory From a Corporate Directory .....	2-18

Searching for Contacts .....	2-19
Searching for Contacts in Your Local Contact Directory .....	2-19
Searching for Contacts in a Corporate Directory .....	2-20
Updating Contacts in Your Local Contact Directory .....	2-20
Deleting Contacts From Your Local Contact Directory .....	2-22
Placing Calls to Contacts .....	2-22
Managing Incoming Calls .....	2-23
Distinguishing Calls .....	2-23
Rejecting Calls .....	2-23
Diverting Calls .....	2-25
Understanding Shared Lines .....	2-26

### **3 Using the Basic Features of Your Phone ..... 3-1**

Placing Calls .....	3-2
Placing Calls Using Speed Dials .....	3-3
Answering Calls .....	3-4
Ending Active Calls .....	3-4
Muting the Microphone .....	3-5
Redialing Numbers .....	3-5
Holding and Resuming Calls .....	3-6
Hosting Conference Calls .....	3-6
Setting Up Conferences .....	3-7
Setting Up a Conference Using the Conference Soft Key .....	3-7
Setting Up a Conference with an Active Call and a Call on Hold .....	3-7
Holding and Resuming Conferences .....	3-8
Splitting Conferences .....	3-9
Ending Conferences .....	3-9
Transferring Calls .....	3-9
Performing a Consultative Transfer .....	3-10
Performing a Blind Transfer .....	3-10
Forwarding Calls .....	3-11
Forwarding Calls Statically .....	3-11
Forwarding Calls Dynamically .....	3-13
Using Do Not Disturb .....	3-14
Managing Speed Dial Entries .....	3-15
Using Voice Mail .....	3-16

**4 Using the Advanced Features of Your Phone . . . . . 4-1**

Handling Multiple Call Appearances . . . . . 4-1

Using Buddy Lists . . . . . 4-2

    Updating Presence Settings . . . . . 4-2

    Selecting Contacts to Monitor . . . . . 4-3

    Blocking Contacts From Viewing Your Status . . . . . 4-4

        Using Your Blocked List to Unblock Contacts . . . . . 4-5

    Monitoring the Status of Contacts in Your Buddy List . . . . . 4-6

    Integrating With Microsoft Office Live Communications Server 2005 . . . . . 4-6

Using Instant Messaging . . . . . 4-7

    Managing Instant Messages . . . . . 4-8

    Sending Instant Messages . . . . . 4-8

Restarting the Phone . . . . . 4-9

**5 Troubleshooting Your Phone . . . . . 5-1**

Installation Configuration . . . . . 5-1

Power and Startup . . . . . 5-2

Controls . . . . . 5-3

Access to Screens and Systems . . . . . 5-4

Calling . . . . . 5-5

Displays . . . . . 5-6

Audio . . . . . 5-6

Testing Phone Hardware . . . . . 5-6

**Safety Notices . . . . . Safety Notices-1**

**Index . . . . . Index-1**





---

# Getting Started with Your Phone

This chapter provides basic installation instructions and information for obtaining the best performance from your SoundStation IP 6000 conference phone.

The SoundStation IP 6000 conference phone is a next-generation phone with a modern industrial design, and the latest advancements in Polycom voice technology.

Some of the key features of the phone include:

- Excellent wideband audio performance
- A console microphone with a range of up to ten feet
- Expansion microphones to accommodate large room sizes
- International language support
- Corporate Directory support

This chapter includes the following topics:

- [Parts List](#) on page 1-2
- [Installing the Phone](#) on page 1-2
- [Features of the Phone](#) on page 1-6
- [Understanding Line and Call Icons](#) on page 1-9
- [Navigating Menus and Entering Data](#) on page 1-10

To read about how to change the settings on your phone, see [Chapter 2, Customizing Your Phone](#). To read about the phone's basic features, see [Chapter 3, Using the Basic Features of Your Phone](#). To read about more advanced features, see [Chapter 4, Using the Advanced Features of Your Phone](#).

If you require additional information or assistance with your new phone, see your system administrator.

## Parts List

The following items are included in your basic SoundStation IP 6000 package:

- SoundStation IP 6000 Conference Phone
- 25-foot Network Cable
- Quick Start Guide

Make sure your conference phone package contains each item. If any item is missing, see your system administrator.

SoundStation IP 6000 Conference Phone

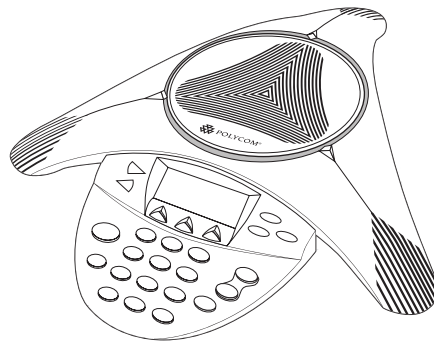

25-foot Network Cable

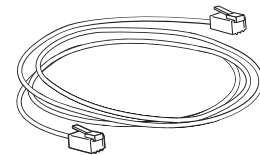

Quick Start Guide



## Optional Accessories

The following items are optional accessories for your phone:

- AC Power Kit with:
  - Power Adapter
  - Regional Power Cord
  - Power Insertion Cable
- External Microphone Kit with two extension microphones

## Installing the Phone

This section describes how to install your phone. It includes the following topics:

- [Connecting Network and Power Sources](#) on page 1-3.
- [Connecting Optional Extension Microphones](#) on page 1-5.

## Connecting Network and Power Sources

There are two ways to connect your phone to the network and a power source. Your system administrator can tell you which of the following methods best suits your teleconferencing needs:

- Power over Ethernet (PoE)
- AC Power

### Power over Ethernet

Power over Ethernet is the default connection for your phone.

#### Note

AC power adapters are not included in the PoE package. If you require one, see your system administrator.

The following figure shows how to connect your phone to the network using a PoE source.

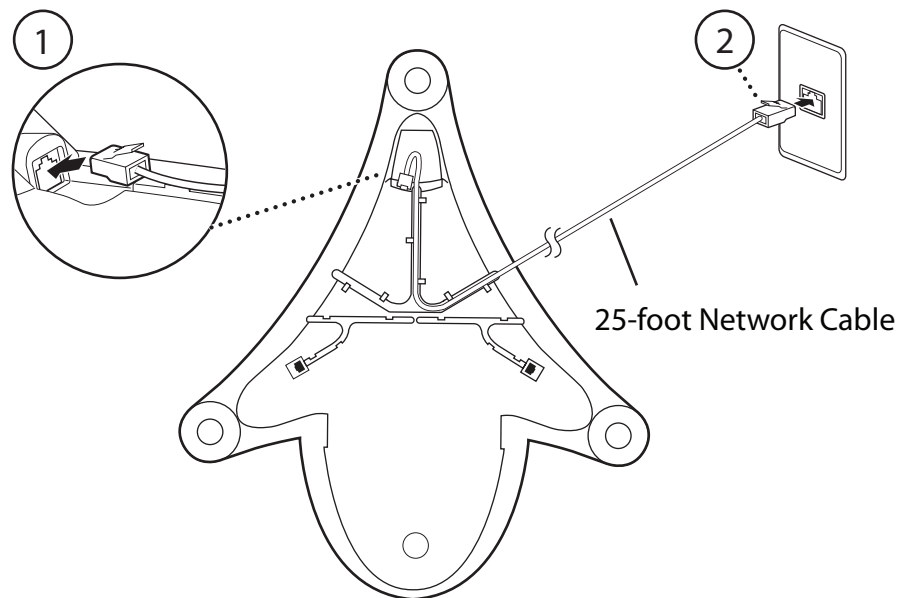

#### To connect the phone using PoE:

1. Connect one end of the 25-foot Network Cable to the LAN jack on the phone.
2. Connect the other end of the 25-foot Network Cable to an available LAN port on the wall or hub/switch device port.

### AC Power

To connect your phone to the network using AC power, make sure you have the optional AC Power Kit. The AC Power Kit contains a Power Adapter, Regional Power Cord, and a Power Insertion Cable.

The following figure shows how to connect your phone to the network using optional AC power.

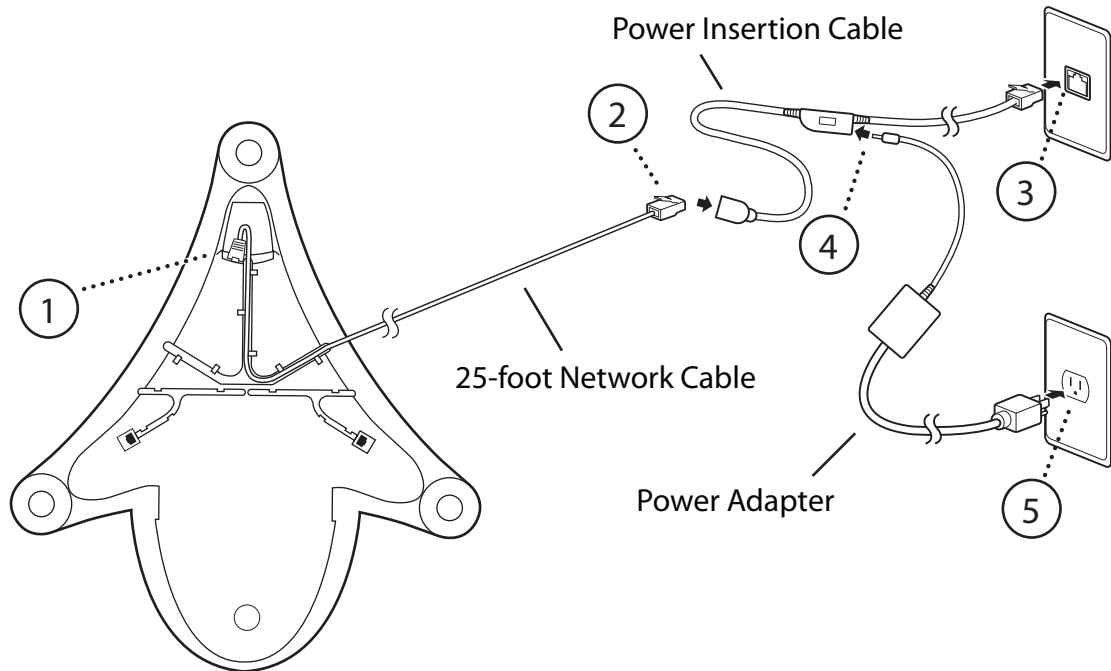

#### To connect the phone using AC power:

1. Connect one end of the 25-foot Network Cable to the LAN jack on the phone.
2. Connect the other end of the 25-foot Network Cable to the Power Insertion Cable.
3. Connect the Power Insertion Cable to an available LAN port on the wall or hub/switch device port.
4. Connect the Power Adapter to the Power Insertion Cable.
5. Connect the Power Adapter (with the attached Regional Power Cord) to the wall outlet.

## Connecting Optional Extension Microphones

Connect the free end of the optional extension microphone cable to one of the microphone connectors on the phone.

The following figure shows the optional extension microphones connected to the microphone connectors on the phone.

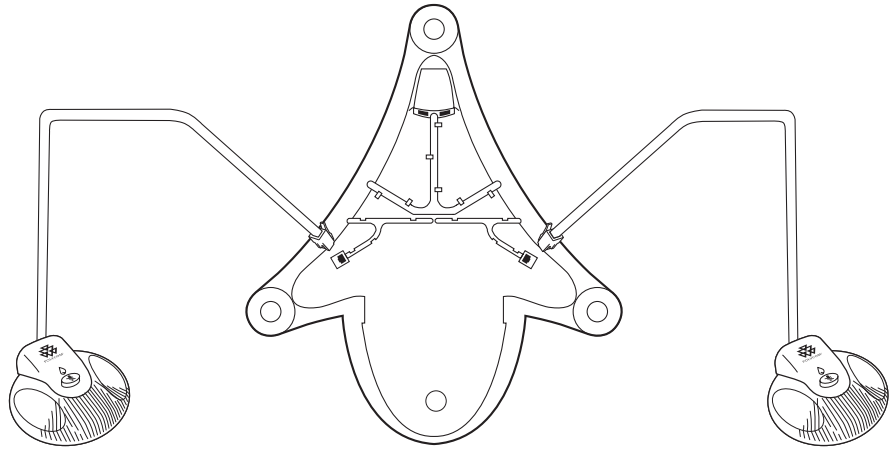

## Features of the Phone



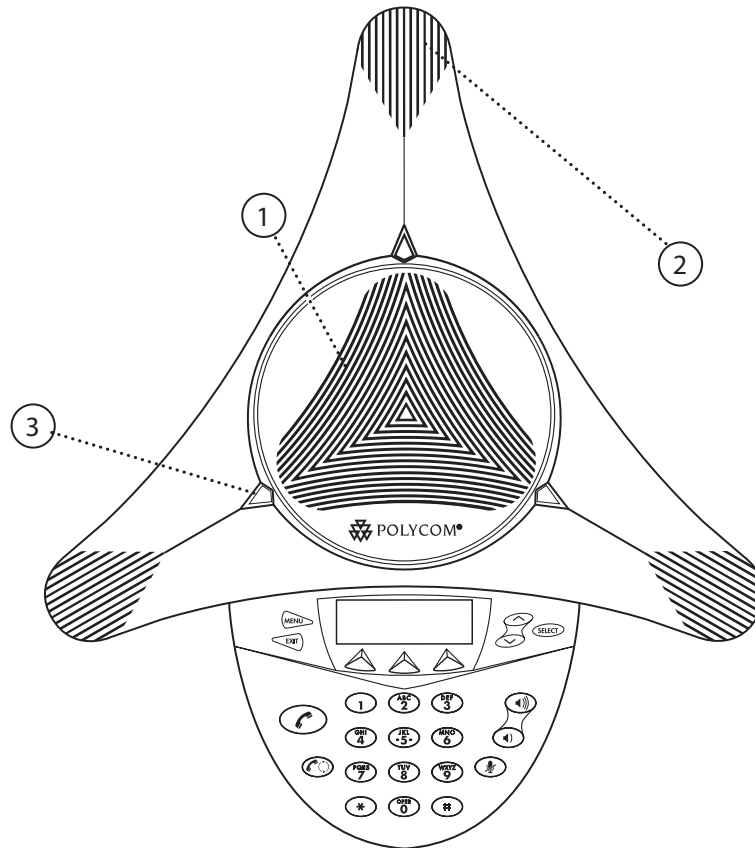

The following figure shows the primary hardware features of your phone console.



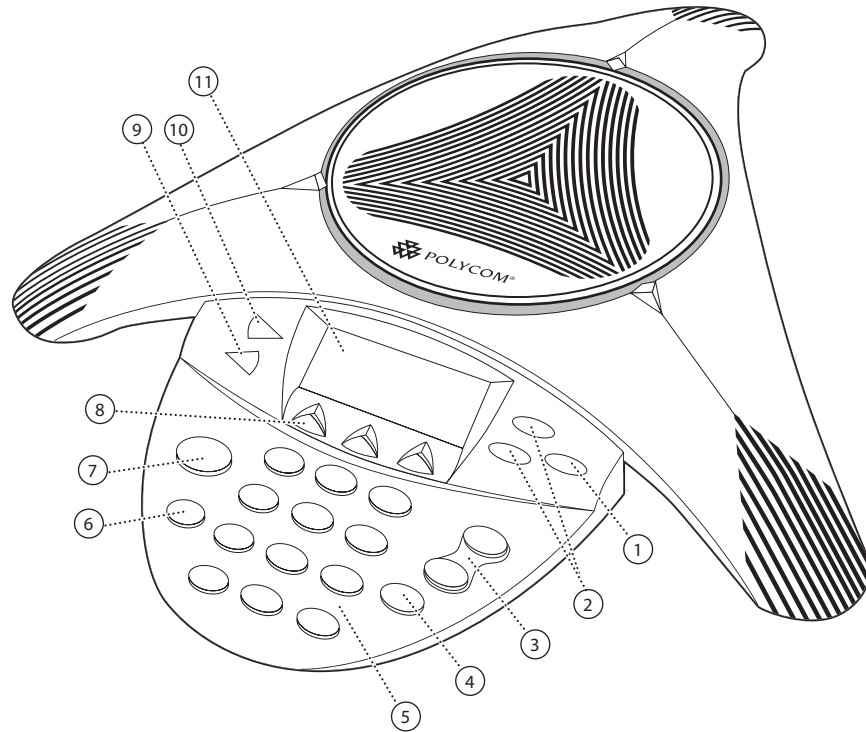



	Feature	Description
1	Speaker	Allows for ringer and hands-free audio output.
2	Microphones	Provide 360° coverage by three internal microphones.
3	LED Indicators	Indicate phone and call status through three bi-color LEDs. The LEDs illuminate to indicate the following normal operational states: <ul style="list-style-type: none"> <li>• Solid red—Power is on, software booting, or your call is muted</li> <li>• Flashing red—You have placed a call on hold</li> <li>• Solid green—A dial-tone is available, dialing is in-progress, or a call is in-progress</li> <li>• Flashing green—A call is incoming</li> </ul>

The following figure shows the primary key buttons, controls, and indicators on your phone console:















	Item	Description
1	Select key 	Allows you to: <ul style="list-style-type: none"> <li>• Select a field of displayed data</li> <li>• Toggle features on or off</li> </ul>
2	Scroll keys 	Allow you to: <ul style="list-style-type: none"> <li>• Scroll through displayed information</li> <li>• Enable or disable fields</li> </ul>
3	Volume keys 	Adjust the volume of the speaker and the ringer.
4	Mute key 	Toggles the microphone on or off during a conversation by doing the following: <ul style="list-style-type: none"> <li>• Stopping local audio from being heard at the far end of the call</li> <li>• Allowing local audio to be heard at the far end of the call</li> </ul>

	Item	Description
5	Dial pad keys	Contain 10 digits, 26 alphabetic characters, and other special characters available in context-sensitive applications.
6	Redial key 	Automatically dials the last number you called.
7	Call key 	Initiates or ends a call.
8	Soft keys 	Select specific context-sensitive functions that display on the screen above each soft key.
9	Exit key 	Exits the current screen and returns to the previous menu.
10	Menu key 	Allows you to: <ul style="list-style-type: none"> <li>• Access additional features and configuration settings</li> <li>• Exit the current screen and return to the idle screen</li> </ul>
11	LCD graphic display	Shows the time and date, and information about calls, messages, soft keys, and other relevant information.



## Understanding Line and Call Icons









Icon	Line or Call State	Description
	Active call	A call is in progress using HD Voice. The active call icons merge into one icon on the phone screen. The following figure shows what displays on the screen during an active call: 
	Conference	A conference is in progress. See <a href="#">Hosting Conference Calls</a> on page 3-6.
	Dialing	The phone is dialing a number.
	Do Not Disturb	You have enabled the Do Not Disturb feature on your phone. Your phone will not ring. See <a href="#">Using Do Not Disturb</a> on page 3-14.
	Forwarding	You have enabled the forwarding feature on your phone. See <a href="#">Forwarding Calls</a> on page 3-11.
	Hold	A call or conference is on hold. See <a href="#">Holding and Resuming Calls</a> on page 3-6 and <a href="#">Holding and Resuming Conferences</a> on page 3-8.
	Registered line	The phone can place and receive calls.
	Registered shared line	The phone, which shares a directory number with another phone, can place and receive calls. See <a href="#">Understanding Shared Lines</a> on page 2-26.
	Ringing	The phone is ringing.
	Unregistered Line	The phone is unable to place and receive calls.
	Voice mail message	You have a new voice mail message. See <a href="#">Using Voice Mail</a> on page 3-16.



## Navigating Menus and Entering Data

To navigate menus and enter data, follow these tips:

**Note**

After 20 seconds of inactivity, the menu system automatically exits to the idle screen unless an edit session is in progress.

If you want to...	Then do this...
Enter the main menu	Press  .
Exit the main menu and return to the idle screen	Press  .
Return to the previous menu	Press  . In some cases, you can press the <b>Back</b> soft key to return to the previous menu.
Scroll through menu items	Use  . When lists appear on more than one page, you can press the * key to Page Up, or press the # key to Page Down.
Scroll through lists or fields	Use  or the <b>Next</b> and <b>Prev</b> soft keys.
Select a menu item	Do one of the following: <ul style="list-style-type: none"> <li>• Scroll to the menu item, and then press  .</li> <li>or</li> <li>• Press the dial pad key that corresponds to the item in the numbered menu list, and then press  .</li> </ul> For example, to select the second item in a menu, press <b>2</b> , and then press  .
Enter text	Press the dial pad keys one or more times. For example, to enter 'A,' press <b>2</b> . To enter 'C,' press <b>222</b> .
Enter numbers, uppercase characters, or lowercase characters	Press the <b>1/A/a</b> soft key one or more times to select numerical, uppercase, or lowercase mode, and then press the dial pad keys one or more times.
Enter special characters	Press the <b>1</b> , <b>*</b> , <b>0</b> , and <b>#</b> keys one or more times.

If you want to...	Then do this...
Enter text in a specific language	Press the <b>Encoding</b> soft key. When in text entry mode, the language the text will display in appears at the top of the screen.
Delete text you entered	Press the << soft key.
View additional soft keys	Press the <b>More</b> soft key.
Enable or disable fields	Use  or the <b>Change</b> soft key.
Enable or disable menu items	Press  .



---

# Customizing Your Phone

You can customize your SoundStation IP 6000 conference phone by adjusting certain settings, including language, volume, time and date, display contrast, backlight intensity, and ring type. You can also add contacts to the phone's local Contact Directory.

This chapter shows you how to customize your phone. It includes the following topics:

- [Configuring Basic Settings](#) on page 2-2
- [Adjusting the Speaker and Ringer Volume](#) on page 2-11
- [Using Call Lists](#) on page 2-11
- [Managing Contacts](#) on page 2-13
- [Managing Incoming Calls](#) on page 2-23
- [Understanding Shared Lines](#) on page 2-26

Some customizations, including shared lines and viewing a Corporate Directory, must be set up by your system administrator.

To learn about your phone's basic features, see Chapter 3, [Using the Basic Features of Your Phone](#). To read about the phone's advanced features, see Chapter 4, [Using the Advanced Features of Your Phone](#).

For more information or assistance with your new phone, see your system administrator.

## Configuring Basic Settings

To configure basic phone settings, press , and then select **Settings > Basic** to view the basic phone settings you can customize.

This section includes the following topics:

- [Updating Preferences](#)
- [Updating the Display Contrast](#)
- [Updating the Backlight Intensity](#)
- [Updating the Ring Tone](#)

### Updating Preferences

The Preferences menu allows you to customize the language that displays on your phone and to specify how the time and date display on the idle screen. You can also enable your phone to save Corporate Directory search results, if Corporate Directory is set up on your phone (see [Searching for Contacts in a Corporate Directory](#) on page 2-20).

#### Updating the Language

The phone supports the following languages. English (Canada) is the default language that displays.

Language (Localization)
1. English (Internal)
2. English (Canada)
3. Chinese (China)
4. Danish (Denmark)
5. Dutch (Netherlands)
6. English (United Kingdom)
7. English (United States)
8. French (France)
9. German (Germany)
10. Italian (Italy)
11. Japanese (Japan)
12. Korean (Korea)

Language (Localization)
13. Norwegian (Norway)
14. Portuguese (Portugal)
15. Russian (Russia)
16. Spanish (Spain)
17. Swedish (Sweden)

### To change the language:

1. Press , and then select **Settings > Basic > Preferences > Language**.

The Language screen displays.



2. Scroll to the language you want, and then press .

The text on the screen changes to the language that you selected.

3. Press  to return to the idle screen.

### Updating the Time and Date Display

The time and date appear on the idle screen of your phone. If the phone cannot obtain a time and date, the display will flash. If this happens, or if the time or date is incorrect, see your system administrator.

You can select from various formats for the time and date display, including whether the time or date displays first (clock order). You can also turn the time and date display off, so the time and date does not display on the idle screen. Select and set options that are right for you.

The following figure shows the default format for the date and time display on the phone screen.



**To update the time and date display:**

1. Press , and then select **Settings > Basic > Preferences > Time and Date**.

The Time and Date screen displays.

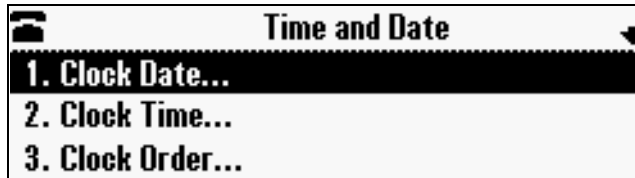

2. Do one of the following:

- To change the date format, press .

or

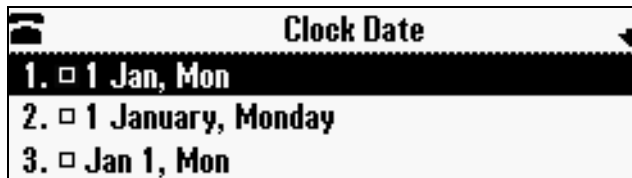

- To change the time format, scroll to **Clock Time**, and then press .

The Clock Date screen or the Clock Time screen displays.



or



3. Scroll to the date or time format you want, and then press .
4. Press  to return to the idle screen. The new date or time format displays on the screen.





**To change the order of the time and date display:**

1. Press , and then select **Settings > Basic > Preferences > Time and Date > Clock Order**.

The Clock Order screen displays.



2. Scroll to the clock order you want, and then press . The default setting is date before time.
3. Press  to return to the idle screen.

**To enable or disable the time and date display:**

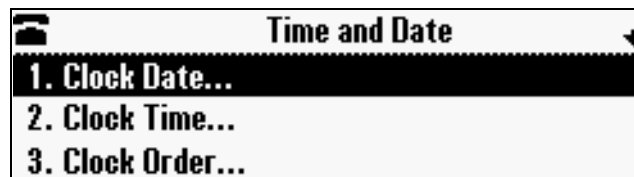

1. Press , and then select **Settings > Basic > Preferences > Time and Date**.

The Time and Date screen displays.

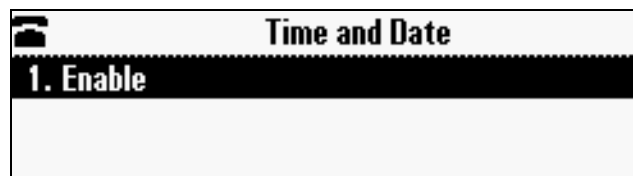

2. Do one of the following:
  - To disable the time and date display, scroll to **Disable**.
 or
  - To enable the time and date display, you do not have to highlight an item. Enable is already highlighted. Go to step 3.



3. Press .
4. Press  to return to the idle screen.

## Updating the Display Contrast

You can set how light or dark the screen appears.

### To adjust the contrast on the phone screen:

1. Press , and then select **Settings > Basic > Contrast**.

The Contrast screen displays.

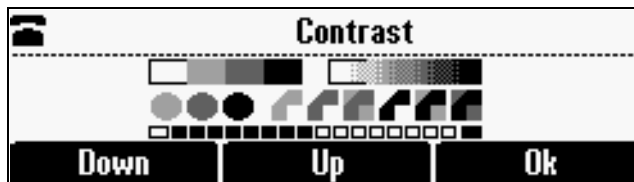

2. Press the **Up** or **Down** soft keys to increase or decrease the display contrast.
3. Press the **Ok** soft key.
4. Press  to return to the idle screen.

## Updating the Backlight Intensity

Backlight intensity on the phone has three modes:

- Backlight On
- Backlight Idle
- Dim

You can modify the Backlight On intensity and the Backlight Idle intensity separately. You can select high, medium, low, and off levels for both.

You can also modify the Maximum Intensity. The Maximum Intensity determines the highest intensity you can choose for the Backlight On and Backlight Idle intensities. For example, if you lower the Maximum Intensity, the highest level for Backlight On and Backlight Idle intensities will be lowered to the same level.

Dim mode intensity is determined by the Backlight On intensity and the Backlight Idle intensity together as follows:

Backlight On Intensity	Backlight Idle Intensity	Dim Intensity
off	off	off
low	dimmer than low	low
medium	dimmer than medium	medium
high	off	medium
high	low	medium
high	medium	medium
high	high	high

The Backlight On mode turns on for following events:

- Any key press
- Incoming calls
- Ending a call, holding a call, resuming a call by the other party
- A voice or instant message received

If you do not press any keys on the phone after 20 seconds of the backlight turning on, the backlight dims (or changes) to medium in the following cases:

- A call is in progress
- A call is on hold
- There is an incoming call (ringing)
- There is an outgoing call (ringing back)
- Any menu shows on the display

In all other cases, the mode changes to Backlight Idle.

**To change the backlight intensity:**

1. Press , and then select **Settings > Basic > Backlight Intensity**.

The Backlight Intensity screen displays.

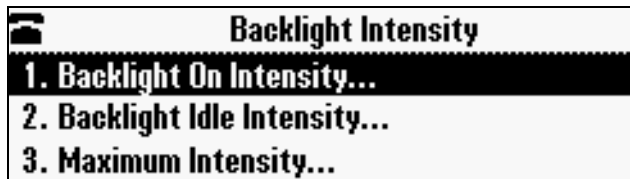

2. Select **Backlight On Intensity**.

The Backlight On Intensity screen displays.



3. Scroll to the intensity you want, and then press . The default Backlight On Intensity is Medium.
4. Press the **Save** soft key.
5. Select **Backlight Idle Intensity**.

The Backlight Idle Intensity screen displays.



6. Scroll to the intensity you want, and then press . The default Backlight Idle Intensity is Medium.
7. Press the **Save** soft key.

8. Select **Maximum Intensity**.

The Maximum Intensity screen displays.

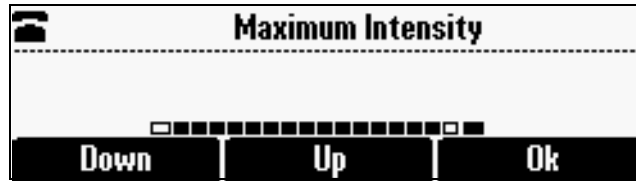

9. Press the **Up** or **Down** soft keys to increase or decrease the maximum intensity the screen can display, and then press the **Ok** soft key.
10. Press  to return to the idle screen.

## Updating the Ring Tone

You can select from many different ring tones to distinguish your phone from your neighbor's. You can also set distinctive ring tones for contacts in your local directory so you can identify callers when your phone rings.

### Selecting a Ring Tone



You can choose a unique ring tone for your phone to identify it when it rings.

#### To select a different ring tone:

1. Press , and then select **Settings > Basic > Ring Type**.

The Ring Type screen displays.



2. Scroll to the ring type you want. To hear the ring type before you select it, press the **Play** soft key. The default ring type is Low Trill.
3. To select the ring type, press .
4. Press  to return to the idle screen.

## Setting Distinctive Ring Tones for Contacts

### Note

Your company's settings may override this feature. For more information, contact your system administrator.

You can set a distinctive ring tone for each contact in your Contact Directory so you can distinguish callers.

### To set a distinctive ring tone for a local contact:

1. Press , and then select **Features > Contact Directory**.

The Directory screen displays.



2. Scroll to the contact for whom you want to assign a distinctive ring tone.
3. Press the **Edit** soft key.

The Edit Contact screen displays.

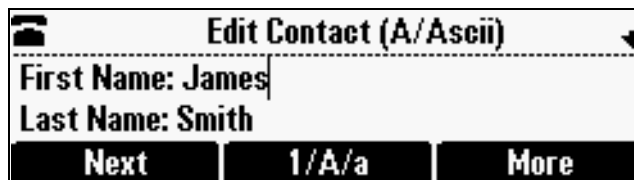

4. Use the **Next** soft key to scroll to **Ring Type**, and then enter a number corresponding to one of the ring types available.

If a ring type is already assigned to the contact, but you want to change it, press the << soft key to delete the existing ring type. Then, enter a number corresponding to one of the ring types available.



### Note

To exit this screen and determine the number associated with a ring type, press the **Menu** key twice, and then select **Settings > Basic > Ring Type**. Each ring type has a number associated with it.



5. Press the **Save** soft key.
6. Press  to return to the idle screen.

## Adjusting the Speaker and Ringer Volume

### To adjust the speaker volume:

>> During a call, press either  or .

### To adjust the ringer volume:

>> When the phone is in the idle state, press either  or .

## Using Call Lists

Your phone maintains lists of missed, received and placed calls. Each list can hold up to 100 entries.

If you miss a call, the idle screen will display a message indicating the number of missed calls you have. To view information about the missed call, view your Missed Calls list (see [Viewing Call Lists](#) on page 2-11). After you view the Missed Calls list, the message on the idle screen is removed.

The following figure shows what the idle screen looks like when you miss a call.



## Viewing Call Lists

You can access any call list from the Call Lists menu, or you can quickly access missed calls from the idle screen.

### To view a call list:

Do one of the following:

- Press , and then select **Features > Call Lists > Missed Calls, Received Calls, or Placed Calls.**

or

- To quickly view the missed calls list, press  from the idle screen.

## Managing Call Lists

You can clear all the records in a call list, or just one record. You can also choose a record in a list and return the call, store the call details in your local Contact Directory, or view detailed information about the particular call.

### To manage a call list:

1. Press **MENU**, and then select **Features > Call Lists**.

The Call Lists screen displays.

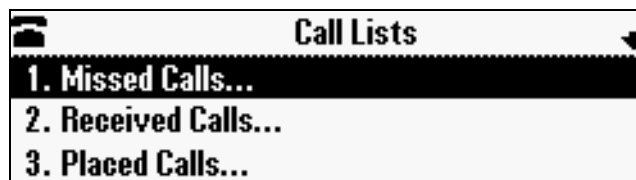

2. Do one of the following:
  - To clear the records in a call list, select **Clear**, and then scroll to either **Missed Calls**, **Received Calls** or **Placed Calls**. Then, press **SELECT**.

The following figure shows the message that displays when you clear a Missed Calls list.

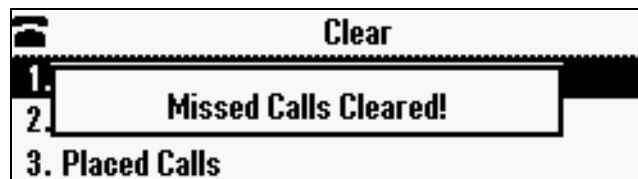

### Note

To manually clear all calls in all call lists, restart the phone. See [Restarting the Phone](#) on page 4-9.

or

- To view and manage a call list, scroll to either **Missed Calls**, **Received Calls**, or **Placed Calls**, and then press **SELECT**. The call list information displays.



The following figure shows a Placed Calls list.

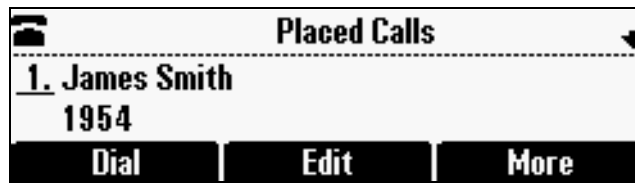

To manage your call list (press the **More** soft key to view all these options):

- To return the call, press the **Dial** soft key.
- To edit the phone number (if necessary) before you dial the number or store the call details in your Contact Directory, press the **Edit** soft key.
- To remove the call from the list, press the **Clear** soft key.
- To store the contact in your Contact Directory, press the **Save** soft key.
- To view information about the call, such as the phone number, the time and duration of the call, and the name of the caller, press the **Info** soft key.

3. Press  to return to the idle screen.

## Managing Contacts

You can store a large number of contacts in your phone's local Contact Directory. Contact your system administrator for the exact number.

You can dial and search for contacts in this directory. You may be able to add, edit, and delete contacts. Contact your system administrator to see if you have read-only access to your local Contact Directory, or if you can update it.

If your system administrator sets up Corporate Directory on your phone, you may also have read access to portions of your Corporate Directory. Your system administrator determines which contacts you can see. You can search for contacts in the Corporate Directory, and add contacts from the Corporate Directory to your local Contact Directory. For more information, see [Searching for Contacts in a Corporate Directory](#) on page 2-20 and [Adding Contacts to Your Contact Directory From a Corporate Directory](#) on page 2-18.

**To view your local Contact Directory:**

>> Press , and then select **Features > Contact Directory**.

The Directory screen displays, listing all the contacts in your directory. Scroll to view all your contacts. You can use the # key to Page Down, and the \* key to Page Up.



**To view your Corporate Directory:**

>> Press , and then select **Features > Corporate Directory**.

The Corporate Directory screen displays, listing all the contacts in your directory. Scroll to view all your contacts. You can use the # key to Page Down, and the \* key to Page Up.



You cannot update the contacts in your Corporate Directory. You can only search for and dial contacts, and add contacts from your Corporate Directory to your local Contact Directory.

## Adding Contacts to Your Local Contact Directory

You can add contacts to your local Contact Directory in the following ways:

- Manually (if you have permission to update your local Contact Directory)
- From a call list
- From a Corporate Directory (if this is set up on your phone)

**Note**

You cannot update Corporate Directory from your phone.

## Adding Contacts Manually

You can update your local Contact Directory manually, instead of importing contact information from a call list or a Corporate Directory.

### To add a contact manually:

1. Press , and then select **Features > Contact Directory**.

The Directory screen displays.



2. To add a contact to your phone's database, press the **Add** soft key.

The Add To Directory screen displays.

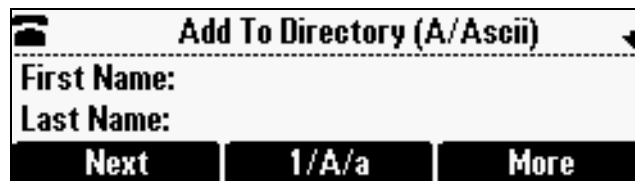

3. Enter the contact information. To move between fields, use the **Next** and **Prev** soft keys. Enter the following information:

#### Note

Your phone may not display all the following fields. For more information, see your system administrator.

- (Optional.) Enter the First Name and Last Name of the contact. (To enter the contact's name, see [Navigating Menus and Entering Data](#) on page 1-10.)
- (Required.) Enter the Contact phone number.  
The phone number must be unique, and must not already exist in the directory. If you save an entry with a non-unique phone number, the entry will not be saved.
- (Optional.) Update the Speed Dial Index number.  
The speed dial index number is automatically assigned to the next available index value. For more information on speed dial index numbers, see [Managing Speed Dial Entries](#) on page 3-15.

- (Optional.) Set the Ring Type.

For information on setting the ring type, see [Updating the Ring Tone](#) on page 2-9.

- (Optional.) Assign a Divert Contact.

The Divert Contact identifies the third party to which you want this contact's calls sent.

- (Optional.) Change the Auto Reject and Auto Divert settings.

If you set the Auto Reject field to enabled, each time the contact calls, the call will be directed to your voice mail system (if a voice mail system is set up). If you set the Auto Divert field to enabled, each time the contact calls, the call will be directed to a third party you specify in the Divert Contact field.

Use the scroll keys or the **Change** soft key to switch between the Enabled and Disabled settings for the Auto Reject and Auto Divert fields.

**Note**

If you do not have a voice mail system set up, enabling the Auto Reject field will have no effect. Each time the contact calls, your phone will ring (unless you choose to divert the contact's calls, or enable call forwarding or Do Not Disturb on your phone).

- (Optional.) Change the Watch Buddy and Block Buddy settings.

If you set the Watch Buddy field to enabled, you can monitor the contact's status. If you set the Block Buddy field to enabled, the contact cannot monitor your status. For more information on monitoring status, see [Using Buddy Lists](#) on page 4-2.

Use the scroll keys or the **Change** soft key to switch between the Enabled and Disabled settings for the Watch Buddy and Block Buddy fields.



4. Press the **Save** soft key.

5. Press  to return to the idle screen.

## Adding Contacts From Call Lists

You can save call information from a call list to your local Contact Directory.

### To add a contact to the local Contact Directory from a call list:

1. Do one of the following:
  - To select a call list, press , and then select **Features > Call Lists > Missed Calls, Received Calls, or Placed Calls**.
  - or
  - To quickly see a list of missed calls, press  from the idle screen.
2. Scroll to the contact's call.
 

You can also use the \* key to Page Up and the # key to Page Down.
3. To save the contact to your Contact Directory, press the **Save** soft key.

The following figure shows the message that displays when you save a contact to your Contact Directory.

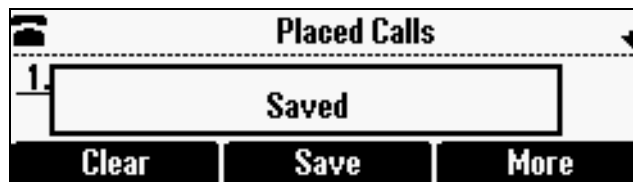

If the contact already exists in your Contact Directory, “Contact already exists” displays.

4. Press  to return to the idle screen.

#### Note

You may want to go to the Contact Directory to see if the contact was saved correctly and to add any missing contact information. To view your Contact Directory, see [Managing Contacts](#) on page 2-13. To update missing contact information, see [Adding Contacts Manually](#) (step 3) on page 2-15.

## Adding Contacts to Your Contact Directory From a Corporate Directory

You can save any contact listed in your Corporate Directory (if it is set up on your phone) to your local Contact Directory.

### To add a contact to your local Contact Directory from a Corporate Directory:

1. Press , and then select **Features > Corporate Directory**.

The Corporate Directory screen displays.



2. Search for the contact, and then scroll to the contact's entry.

For information on how to search for a contact, see [Searching for Contacts in a Corporate Directory](#) on page 2-20.

3. Press the **View** soft key.

The Contact screen displays.

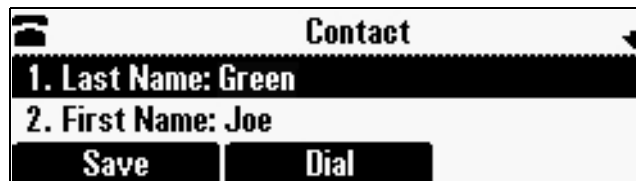

4. To save the contact to the local Contact Directory, press the **Save** soft key.

“Saved” displays on the screen. Only the first name, last name, and phone number are saved.

If the contact already exists in your local Contact Directory, “Contact already exists” displays.

5. Press  to return to the idle screen.

#### Note

You may want to go to the Contact Directory to see if the contact was saved correctly and to add additional contact information. To view your Contact Directory, see [Managing Contacts](#) on page 2-13. To update contact information, see [Adding Contacts Manually](#) (step 3) on page 2-15.

## Searching for Contacts

You can search for contacts in your local Contact Directory, or in a Corporate Directory (if this is set up on your phone).

### Searching for Contacts in Your Local Contact Directory

Search for a contact by scrolling through the directory, or entering specific search criteria.

#### To search for a contact in the local Contact Directory:

1. Press , and then select **Features > Contact Directory**.

The Directory screen displays.



2. Press the **Search** soft key. Then, enter the first few characters of the contact's first or last name, and then press the **Search** soft key again.

The Directory Search screen displays a list of successful matches.



3. Scroll to the contact you are searching for.  
You can dial, edit, or delete the contact.
4. Press  to return to the idle screen.

## Searching for Contacts in a Corporate Directory

Search for a contact by scrolling through the directory, or entering specific search criteria.

### Note

You can enable your phone to save Corporate Directory search results, and to remember the last person you viewed in the directory. Whenever you re-display Corporate Directory, the last person you viewed will display. If you searched for a person, the results of the last search you submitted will display. To enable this feature, press the **Menu** key, and then select **Settings > Basic > Preferences > Corporate Directory > Retain Search**. Scroll to **Enable**, and then press the **Select** key.

### To search for a contact in the Corporate Directory:

1. Press , and then select **Features > Corporate Directory**.

The Corporate Directory screen displays.



2. Press the **Search** soft key. Then, enter the first few characters of the contact's first or last name, and then press the **Submit** soft key.

The screen displays a list of successful matches. Scroll to the contact you are searching for.

From this screen, you can press the **Dial** soft key to dial the contact, or press the **View** soft key, and then save the contact to your local Contact Directory.

3. Press  to return to the idle screen.

## Updating Contacts in Your Local Contact Directory

You can update contact information for contacts in your local Contact Directory. You cannot update information for contacts in your Corporate Directory.



**To update a contact in your local Contact Directory:**

1. Press , and then select **Features > Contact Directory**.

The Directory screen displays.



2. Scroll to the contact whose information you want to update, or search for the contact (see [Searching for Contacts in Your Local Contact Directory](#) on page 2-19).

You can also use the \* key to Page Up and the # key to Page Down.

3. Press the **Edit** soft key.

The Edit Contact screen displays.

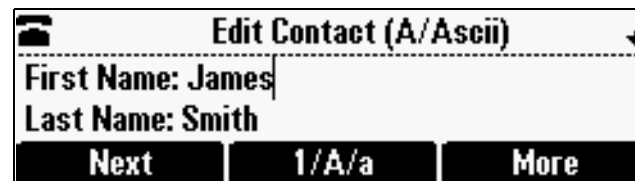

4. Update the contact information. Use the **Next** and **Prev** soft keys to scroll between fields.

For information on the fields you can update, see [Adding Contacts Manually](#) (step 3) on page 2-15.

5. Press the **Save** soft key.
6. Press  to return to the idle screen.

## Deleting Contacts From Your Local Contact Directory

You can delete contacts from your local Contact Directory, but not from your Corporate Directory.

### To delete a contact from the local Contact Directory:

1. Press , and then select **Features > Contact Directory**.

The Directory screen displays.



2. Scroll to the contact you want to delete. Or, search for the contact (see [Searching for Contacts in Your Local Contact Directory](#) on page 2-19).

You can also use the \* key to Page Up and the # key to Page Down.

3. Press the **Delete** soft key.

The contact is deleted from the directory.

4. Press  to return to the idle screen.

## Placing Calls to Contacts

You can place calls to contacts from your local Contact Directory or from your Corporate Directory (if this is set up on your phone).

### To place a call to a contact in the local Contact Directory:

1. Press , and then select **Features > Contact Directory**.

The Directory screen displays.



2. Scroll to the contact you want to call. Or, search for the contact (see [Searching for Contacts in Your Local Contact Directory](#) on page 2-19).

You can also use the \* key to Page Up and the # key to Page Down.

3. Press the **Dial** soft key.

**To place a call to a contact in the Corporate Directory:**

1. Press , and then select **Features > Corporate Directory**.

The Corporate Directory screen displays.



2. Scroll to the contact you want to call. Or, search for the contact (see [Searching for Contacts in a Corporate Directory](#) on page 2-20).  
You can also use the \* key to Page Up and the # key to Page Down.
3. Press the **Dial** soft key.

## Managing Incoming Calls

You can manage incoming calls from the contacts in your directory by doing the following:

- Setting up a distinctive ring tone for a contact.
- Rejecting calls from a particular contact by sending the call to your voice mail system. (If you do not have a voice mail system set up, the call will still ring on your phone.)
- Diverting calls from a particular contact to another party.

## Distinguishing Calls

You can customize your phone so that you can distinguish callers by certain ring tones. For information on setting a distinctive ring tone for a particular contact, see [Setting Distinctive Ring Tones for Contacts](#) on page 2-10.

## Rejecting Calls

You can customize your phone so that incoming calls from a particular party are immediately sent to your voice mail system. (If you do not have a voice mail system set up, the call will still ring on your phone.)

### Note

Rejecting calls is not available on shared lines.

**To send incoming calls from a particular contact directly to voice mail:**

1. Press , and then select **Features > Contact Directory**.

The Directory screen displays.





2. Scroll to the contact. Or, search for the contact (see [Searching for Contacts in Your Local Contact Directory](#) on page 2-19).

You can also use the \* key to Page Up and the # key to Page Down.

3. Press the **Edit** soft key.

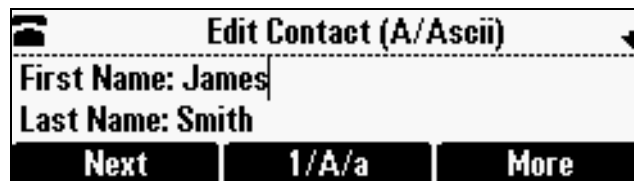
The Edit Contact screen displays.



4. Use the **Next** soft key to scroll to the **Auto Reject** field, and then change the Auto Reject setting to **Enabled**. Use the scroll keys or the **Change** soft key to select Enabled.
5. Press the **Save** soft key.
6. Press  to return to the idle screen.

## Diverting Calls

You can customize your phone so that incoming calls from a particular party are transferred directly to a third party.

### To divert incoming calls from a contact to a third party:

1. Press , and then select **Features > Contact Directory**.

The Directory screen displays.





2. Scroll to the contact for whom you want to transfer calls. Or, search for the contact (see [Searching for Contacts](#) on page 2-19).

You can also use the \* key to Page Up and the # key to Page Down.

3. Press the **Edit** soft key.

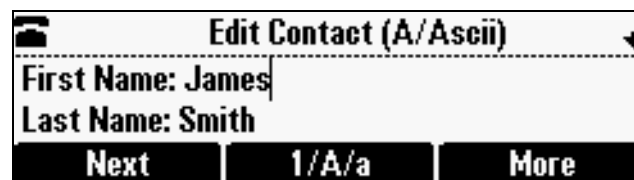
The Edit Contact screen displays.



4. Use the **Next** soft key to scroll to the **Divert Contact** field, and then enter the number of the party to whom you want to divert the call.
5. Use the **Next** soft key to scroll to the **Auto Divert** field, and then change the Auto Divert setting to **Enabled**. Use the scroll keys or the **Change** soft key to select Enabled.
6. Press the **Save** soft key.
7. Press  to return to the idle screen.

## Understanding Shared Lines

**Note**

Shared lines is an optional feature that your system administrator sets up. Your system may not support it. For more information, contact your system administrator.

If two phones share a line, an incoming call to one number will cause both phones to ring. The call can be answered by either phone, but not both. If your phone shares a line, a shared line icon that is half black and half grey displays on the screen.

The following figure shows the shared line icon at the top left of the screen.

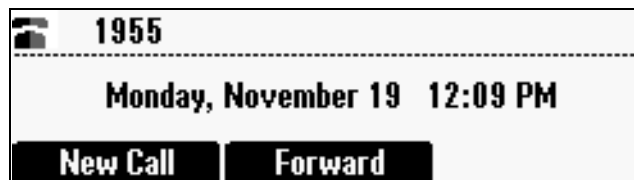

The shared line icon changes to a moving icon, and the console's LEDs glow a steady red, when the line is in use remotely.

Calls on shared lines can be transferred, put on hold, or added to a conference.

**Note**

You cannot forward or reject calls on shared lines.

For information on answering calls with shared lines, see [Answering Calls](#) on page 3-4.

---

# Using the Basic Features of Your Phone

Your SoundStation IP 6000 conference phone is designed to be used like a regular conference phone on a public switched telephone network (PSTN). You can place calls, transfer a call to someone else, conduct a multi-party conference call, or perform other basic and more advanced functions.

At any time, only one active call may be in progress on your phone. The active call is the one that has audio associated with it. In addition to an active call, your phone can handle up to seven other calls, including conference calls, on hold. Your phone can handle a total of eight calls at one time.

This chapter provides introductory information and basic operating instructions for the phone. It includes the following topics:

- [Placing Calls](#) on page 3-2
- [Answering Calls](#) on page 3-4
- [Ending Active Calls](#) on page 3-4
- [Muting the Microphone](#) on page 3-5
- [Redialing Numbers](#) on page 3-5
- [Holding and Resuming Calls](#) on page 3-6
- [Hosting Conference Calls](#) on page 3-6
- [Transferring Calls](#) on page 3-9
- [Forwarding Calls](#) on page 3-11
- [Using Do Not Disturb](#) on page 3-14
- [Managing Speed Dial Entries](#) on page 3-15
- [Using Voice Mail](#) on page 3-16

For information on the advanced features of your phone, see [Chapter 4, Using the Advanced Features of Your Phone](#).

## Placing Calls

You can place a call off-hook (with a dial tone), or on-hook (without a dial tone). If you place a call off-hook, you have the option of dialing a contact using a URL, or using the last call return (LCR) feature (if enabled for your phone). You can also place calls (on-hook and off-hook) using speed dial numbers (see [Placing Calls Using Speed Dials](#) on page 3-3).

The phone displays the duration of active calls on the phone screen. The following figure shows an active call to Jane at directory number 1951 that has lasted for one minute and ten seconds.

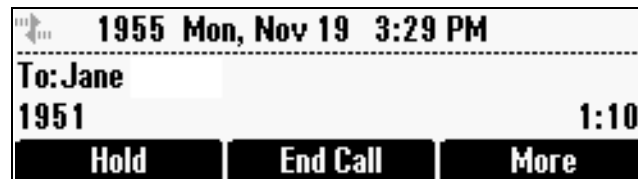

### To place a call off-hook:

1. To obtain a dial tone, press  or the **New Call** soft key.
2. Do one of the following:
  - Enter the desired number, and then press the **Send** soft key.
  - To dial a URL, press the **URL** soft key, and then enter the URL of the contact. Then, press the **Send** soft key.

To enter the number and letters displayed on a key, press the key one or more times quickly. To enter “@”, press the # key. To enter “.”, press the \* key.

  - To call the last person that called you (last call return), press the **LCR** soft key, and then follow the voice prompts.

### Note

Last call return (LCR) is an optional feature that your system administrator sets up. Your system may not support it. For more information, contact your system administrator.

The active call displays on the screen showing the call duration and destination.

### To place a call on-hook:

- >> Enter the desired number, and then press the **Dial** soft key.

The active call displays on the screen showing the call duration and destination.



**Note**

Instead of entering a phone number from memory, you can access call lists, directories, and speed dial lists to display and dial the number for you.

- To access a call list, press the **Menu** key, and then select **Features > Call Lists > Missed Calls, Received Calls, or Placed Calls**. Scroll to the call you want to dial, and then press the **Dial** soft key. For more information, see [Using Call Lists](#) on page 2-11.
- To access your Contact Directory or Corporate Directory (if enabled for your phone), press the **Menu** key, and then select **Features > Contact Directory or Corporate Directory**. Scroll to or search for the contact you want to dial, and then press the **Dial** soft key. For more information, see [Managing Contacts](#) on page 2-13.
- To place a call using a speed dial index number, press the up scroll key, scroll to the party you want to call, and then press the **Dial** soft key. For more information on other ways to use speed dial, see [Placing Calls Using Speed Dials](#) on page 3-3.

## Placing Calls Using Speed Dials

Use a speed dial index number for quick dialing. Speed dial index numbers are associated with entries in your Contact Directory. For information on managing speed dial entries from your Contact Directory, see [Managing Speed Dial Entries](#) on page 3-15.

### To place a call using a speed dial index number:

1. Press .

The Speed Dial Info screen displays.

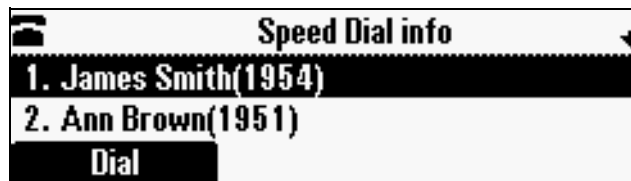

2. Do one of the following:
  - If you know the contact's speed dial index number, enter the number.
  - or
  - If you do not know the contact's speed dial index number, scroll to the contact, and then press the **Dial** soft key.

The call is placed.

## Answering Calls

### To answer a call:

>> Press the **Answer** soft key.

The three LEDs flash green when the phone rings.

#### Note

To ignore Incoming calls, press the **Reject** soft key (for private lines) or the **Silence** soft key (for shared lines). To prevent your phone from ringing, enable the **Do Not Disturb** feature (see [Using Do Not Disturb](#) on page 3-14).

You can forward incoming calls by pressing the **Forward** soft key (see [Forwarding Calls Dynamically](#) on page 3-13).

If you set up your phone with a silent ring, press the **Answer** soft key to answer the call.

### To answer a call on a shared line:

1. Answer the incoming call.
2. Press the **Hold** soft key.

Anyone on another phone configured to use the same shared line can take the call by selecting the call on their phone screen.

## Ending Active Calls

### To end a call:

>> Do one of the following

- Press .

or

- Press the **End Call** soft key.

#### Note

You cannot end a call that is on hold until you resume the call (that is, you must press the **Resume** soft key before you press the **End Call** soft key).

## Muting the Microphone

### To mute the microphone:

>> During a call, press .

The three console LEDs glow red to indicate that the other party (or parties) cannot hear you. You can still hear all other parties while Mute is enabled.

To turn off the Mute feature, press  again.

### To mute the microphone if you use external microphones:

>> Press  on the phone or the  button on the top of the external microphones.

To turn off the Mute feature, press  again.

## Redialing Numbers

You can redial the last number you dialed, or search a list of placed calls to find a previously-dialed number.

### To redial the last number dialed:

>> Press .

### To redial a previously dialed number:

1. Press , and then select **Features** > **Call Lists** > **Placed Calls**.

The Placed Calls screen displays.



2. Scroll to the number you want to redial, and then press the **Dial** soft key.

## Holding and Resuming Calls

You can place up to eight calls on hold on your phone.

(For information on placing conference calls on hold, see [Holding and Resuming Conferences](#) on page 3-8.)

### To place a call on hold:

>> During a call, press the **Hold** soft key. The console LEDs flash red to indicate that a call is on hold.

The following screen shows Jane Smith on hold. The Resume soft key now displays on the screen.

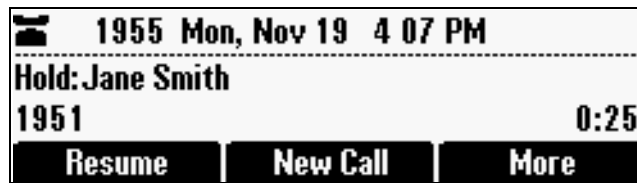

### To resume a call on hold:

>> While a call is on hold, press the **Resume** soft key.

#### Note

To end a call on hold, you must resume the call first.

## Hosting Conference Calls

You can create a conference with up to two other parties using the phone's local conference feature. To quickly set up a conference, you can use the **Join** soft key to create a conference between an active call and a call on hold.

After you set up a conference, you can hold the conference call, split the conference call into individual calls on hold, or end the conference call (and your connection to the conference call participants).

This section includes the following topics:

- [Setting Up Conferences](#) on page 3-7
- [Holding and Resuming Conferences](#) on page 3-8
- [Splitting Conferences](#) on page 3-9
- [Ending Conferences](#) on page 3-9

## Setting Up Conferences

You can set up a conference in one of two ways:

- Using the **Confrnc** soft key.
- Using the **Join** soft key, if you have an active call and a call on hold.

### Setting Up a Conference Using the Conference Soft Key

**To set up a conference using the Conference soft key:**

1. Call the first party. See [Placing Calls](#) on page 3-2.
2. Press the **Confrnc** soft key. The active call is placed on hold.

#### Note

If configured for single key-press conferences, the conference participant hears the dial tone and ringback when the conference host places the call to the new party.

3. Enter the number of the second party, and then press the **Send** soft key.
4. When the second party answers, press the **Confrnc** soft key to join all parties in the conference.

#### Note

If configured for single key-press conferences, you do not have to press the **Confrnc** soft key again.

The Active:Conference screen displays.

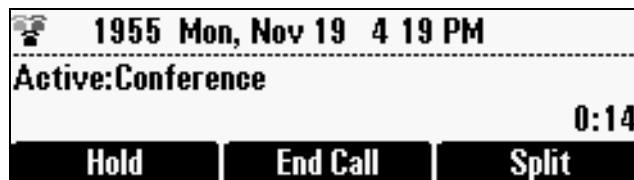

### Setting Up a Conference with an Active Call and a Call on Hold

If you are currently in an active call, and you have another call on hold, you can create a conference call between the active call, the call on hold, and yourself, by pressing the **Join** soft key.

**To set up a conference call with an active call and a call on hold:**

>> If you have an active call and a call on hold, press the **Join** soft key.  
The Active:Conference screen displays.

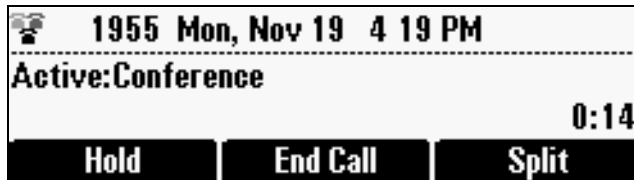

A conference is created with the active call, the call on hold, and yourself.

## Holding and Resuming Conferences

When you place a conference call on hold, you place all other conference participants on hold.

**To place a conference call on hold:**

>> From the Active:Conference screen, press the **Hold** soft key.

The Hold:Conference screen displays. The other parties in the conference call are put on hold.

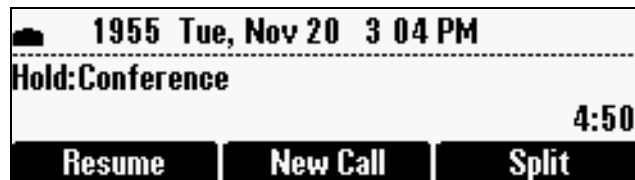

From the Hold:Conference screen, you can do the following:

- To resume the conference call, press the **Resume** soft key. The Active:Conference screen will display again.
- To place a call to a new party, press the **New Call** soft key. The conference remains on hold, and the new call becomes the active call.
- To end the conference call and split the conference into two separate calls on hold, press the **Split** soft key.

## Splitting Conferences

When a conference has been established, a **Split** soft key is available. When you split a conference, you end the conference and put all parties on hold.

### To split a conference:

>> From the Active:Conference screen, press the **Split** soft key.

The conference ends, and all calls are split into individual calls and put on hold.

## Ending Conferences

You can end a conference, and your connection to the other parties, by pressing the **End Call** soft key. When you use the End Call soft key, the other parties remain connected.

### To end a conference:

>> From the Active:Conference screen, press the **End Call** soft key.

The two other parties remain connected.

## Transferring Calls

A call can be transferred in one of three ways:

- Consultative transfer – You have the option of either talking to the party to whom you are transferring the call, or you can choose not to talk to the party, and complete the transfer when you hear the party's ring-back sound.
  - [Performing a Consultative Transfer](#) on page 3-10.
- Blind transfer – The call is automatically transferred after you dial the number of the party to whom you want to transfer the call. You do not have the option of talking to the party.
  - [Performing a Blind Transfer](#) on page 3-10.
- Attended transfer – The parties are automatically connected to each other after you exit a conference.
  - Set up a conference call and then end your participation. For more information, see [Setting Up Conferences](#) on page 3-7 and [Ending Conferences](#) on page 3-9.

## Performing a Consultative Transfer

Perform a consultative transfer if you want to talk to the party to whom you are transferring the call. Or, you can choose not to talk to the party. In this case, you wait for the party's ring-back sound, and then transfer the call.

### To transfer a call:

1. During a call, press the **Trnsfer** soft key. The active call is placed on hold.
2. Place a call to the party to whom you want to transfer the call. See [Placing Calls](#) on page 3-2.
3. When you hear the ring-back sound, press the **Trnsfer** soft key. The transfer is complete.

If you want to talk privately to the person to whom you are transferring the call before the transfer is complete, wait until the person answers the call, talk to the person, and then press the **Trnsfer** soft key.

To cancel the transfer before the call connects, press the **Cancel** soft key.

## Performing a Blind Transfer

When you use a blind transfer, you transfer a call without speaking to the party to whom you are transferring the call. The call is automatically transferred as soon as you dial the party's number.

### To perform a blind transfer:

1. During a call, press the **Trnsfer** soft key.

The following screen, with the **Blind** soft key, displays.



2. Press the **Blind** soft key.

The **Blind** transfer to screen displays.

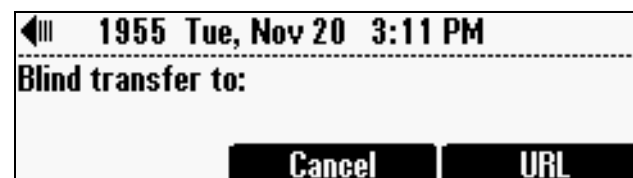

3. Place a call to the party to whom you want to transfer the call. See [Placing Calls](#) on page 3-2.

The call automatically transfers to the party you specified.



## Forwarding Calls

### Note

Your company's settings may override this feature. For more information, contact your system administrator.  
Call forwarding is not available on shared lines.

You can set up your phone to forward incoming calls to another party (static forwarding), or you can forward a call as your phone rings (dynamic forwarding). Your phone will forward calls even if you enable the Do Not Disturb Feature.

You can also reject calls from a particular contact (by sending the call to your voice mail system), or divert calls from a particular contact to another party. For more information, see [Managing Incoming Calls](#) on page 2-23.

### To access forwarding options:

- Press , and then select **Features > Forward**.
- or
- From the idle screen, press the **Forward** soft key.

## Forwarding Calls Staticly

You can set up your phone to forward calls to another number.

### To forward calls to another extension:

1. From the idle screen, press the **Forward** soft key.  
The Forwarding Type Select screen displays.

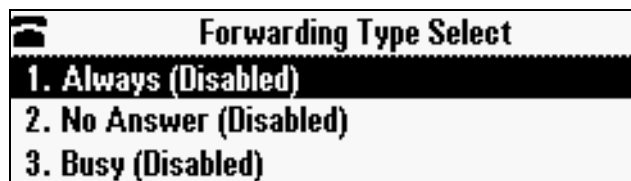

2. Scroll to the forwarding type you want, and then press . The options are:
  - **Always** – To forward all incoming calls.
  - **No Answer** – To forward all unanswered incoming calls.
  - **Busy** – To forward calls that arrive when you are already in a call.

3. Do one of the following:

- If you selected **Always**, the Call Forward Always screen displays. Enter a number to forward all incoming calls to.

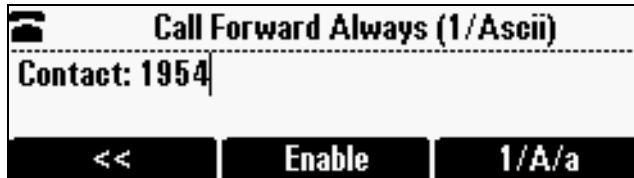

- If you selected **No Answer**, the Call Forward No Answer screen displays. Do the following (use the **Next** and **Prev** soft keys to move between fields):
  - a In the **Contact** field, enter a number to forward all unanswered incoming calls to.
  - b In the **Forward After Rings** field, enter how many rings to wait before forwarding the call (one ring is approximately six seconds).



- If you selected **Busy**, the Call Forward Busy screen displays. Enter a number to forward all future incoming calls to when you are already in another call.

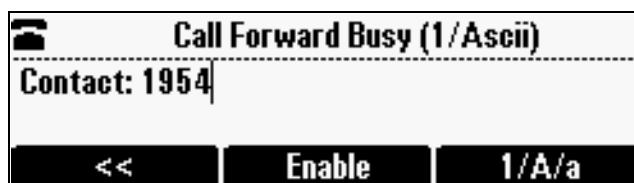

4. Press the **Enable** soft key.

If you selected the forwarding type **Always**, a moving arrow displays on the idle screen next to the directory number.

**To disable call forwarding:**

1. From the idle screen, press the **Forward** soft key.

The Forwarding Type Select screen displays, showing the forwarding type that is enabled.

The following screen shows the forwarding type “Always” enabled.

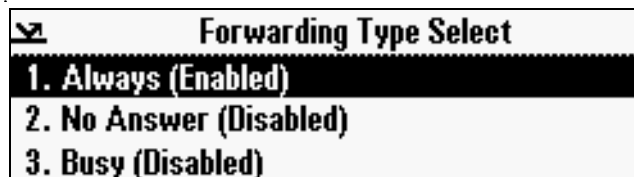

2. Scroll to the forwarding type you want to change, and then press **SELECT**.

A screen displays showing the details of the forwarding type you want to disable.



3. To turn off call forwarding, press the **Disable** soft key.

## Forwarding Calls Dynamically

You can manually forward a call to another number while your phone rings.

**To forward an incoming call to another extension:**

1. While your phone rings, press the **Forward** soft key.

The Call Forwarding screen displays.



2. Enter the number to forward the incoming call to.

Your phone displays the last number you forwarded calls to (either statically or dynamically). If you previously set a forwarding number and want to enter a new one, use the << soft key to delete the number.

3. Press the **Forward** soft key.

The incoming call is forwarded to the other party. If call forwarding is disabled, all future calls will not be forwarded and forwarding will remain disabled.

## Using Do Not Disturb

To prevent your phone from ringing, activate the Do Not Disturb feature.

Calls you receive while Do Not Disturb is enabled will display in your Missed Calls Call List (see [Using Call Lists](#) on page 2-11). If you have chosen to forward your calls to another number, calls will be sent to that number if Do Not Disturb is enabled.



### To enable and disable Do Not Disturb:

1. Press , and then select **Features**.

The Features screen displays. If Do Not Disturb is not highlighted, scroll to it.



2. To toggle Do Not Disturb on or off, press .

When you enable Do Not Disturb, a flashing icon, , displays at the top left of the screen. When you disable Do Not Disturb, the registered line icon, , displays instead.

The following figure shows what the Features menu looks like with Do Not Disturb enabled.



3. Press  to return to the idle screen.

If you enabled Do Not Disturb, the idle screen displays **Do Not Disturb** and flashing icons next to the directory number.

The following figure shows what the idle screen looks like with Do Not Disturb enabled.



## Managing Speed Dial Entries

Use the speed dial feature for fast, automated dialing. To use speed dial, you enter a speed dial index number instead of entering a complete phone number.

When you create a Contact Directory entry, the phone automatically assigns a Speed Dial Index number to the entry. You can change the index number or delete it.

### Note

Only entries in your Contact Directory can be set up as speed dial entries. To create a new Contact Directory entry with a speed dial index number, see [Adding Contacts to Your Local Contact Directory](#) on page 2-14.

The following steps describe how to update a speed dial entry for a user. For information on how to place a call using a speed dial number, see [Placing Calls Using Speed Dials](#) on page 3-3.

### To update a speed dial entry in your contact directory:

1. Press , and then select **Features > Contact Directory**.

The Directory screen displays.



2. Scroll to the user's entry, and then press the **Edit** soft key.

The Edit Contact screen displays.



3. Use the **Next** and **Prev** soft keys to scroll to the Speed Dial Index field, and then update the speed dial index number. Use the << soft key to update an existing entry.
4. Press the **Save** soft key.
5. Press  to return to the idle screen.

## Using Voice Mail

### Note

Voice mail is an optional feature that your system administrator sets up. Your system may not support it. For more information, contact your system administrator. Screen options may vary with your application. Voice mail may be accessible with a single key press. Contact your system administrator about this option.

Your voice mail is saved in a centralized location and may be accessed from your phone. Your phone may indicate voice mail by the following:

- An icon, , on the phone screen
- A stutter dial tone instead of a normal dial tone

**To listen to voice mail messages:**

1. Press , and then select **Features > Messages > Message Center**.

The Messages screen displays, indicating the number of urgent, new, and old messages you have.



2. To listen to your voice mail, press the **Connect** soft key, and then follow the voice or visual prompts on the screen.
3. Press  to return to the idle screen.





# Using the Advanced Features of Your Phone

This chapter provides operating instructions for the advanced features of the SoundStation IP 6000 conference phone. If you require additional information or assistance with these features, contact your system administrator.

For information on the basic features of your phone, see Chapter 3, [Using the Basic Features of Your Phone](#).

This chapter includes the following topics:

- [Handling Multiple Call Appearances](#) on page 4-1
- [Using Buddy Lists](#) on page 4-2
- [Using Instant Messaging](#) on page 4-7
- [Restarting the Phone](#) on page 4-9

## Handling Multiple Call Appearances

Your system administrator can set up your phone to have one or more call appearances. If your phone is set up to have multiple call appearances, your phone screen can display information for multiple calls, and you can handle active and held calls at the same time. Your phone can handle a maximum of eight different calls, or eight “appearances” at one time.

If two or more calls are taking place, the phone displays a counter at the top right of the display. For example, in the following figure, “1/3” indicates that the call to Jack Smith is the first one out of a total of three.

To display the other two calls on hold, use the scroll keys.

	1955 4 34 PM	1/3
-----		
To: Jack Smith		
1952		0:15
Hold	End Call	More

## Using Buddy Lists

### Note

Monitoring the status (presence) of contacts in a buddy list is an optional feature that your system administrator enables. Your system may not support it. For more information, contact your system administrator.

A buddy list is a list of users/devices whose status, or “presence,” you can monitor. Your contacts update their presence setting (for example, Be right back, Out to lunch, or Busy), and you can view their status in real time from your phone’s Buddy Status screen. If you like, you can block others from monitoring your status.

Your phone can “watch” the status of up to eight other phones. These phones form your “buddy list.” Your phone can be monitored by up to eight other phones.

If your phone is configured to work with Microsoft Office Live Communications Server 2005, the behavior of presence settings and buddy lists is different. For more information, see [Integrating With Microsoft Office Live Communications Server 2005](#) on page 4-6, or contact your system administrator.

## Updating Presence Settings



Your presence setting indicates your status (either online, busy, be right back, away, out to lunch, offline, or do not disturb). Update your presence setting so that other users can monitor your status from their phones.

### To change your presence setting:

1. Do one of the following:
  - Press , and then select **Features > Presence > My Status**.
  - or
  - From the idle screen, press the **MyStat** soft key.

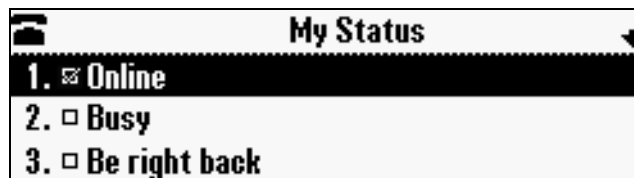
The My Status screen displays.



2. Scroll to the status you want, and then press . The default status is Online.
3. Press  to return to the idle screen.

The following figure shows what the idle screen looks like when you assign a presence status (in this case, “Be right back”). If you assign the status “Online” (the default status), the presence status does not display on the screen.

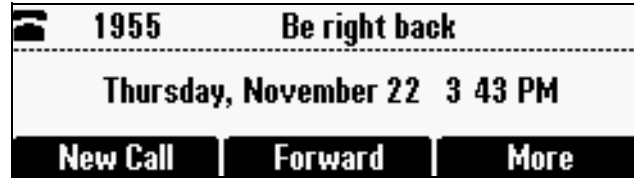

## Selecting Contacts to Monitor

Select the contacts whose presence you want to monitor by updating the contacts in your buddy list. You add contacts to your buddy list from your local Contact Directory. To view the status of contacts in your buddy list, see [Monitoring the Status of Contacts in Your Buddy List](#) on page 4-6.

### Note

If your call server is Microsoft Office Live Communications Server 2005, see [Integrating With Microsoft Office Live Communications Server 2005](#) on page 4-6.

### To update your buddy list:

1. Press , and then select **Features > Contact Directory**.

The Directory screen displays.



2. Scroll to the contact. Or, search for the contact (see [Searching for Contacts in Your Local Contact Directory](#) on page 2-19).

You can use the \* key to Page Up and the # key to Page Down.

3. Press the Edit soft key.

The Edit Contact screen displays.

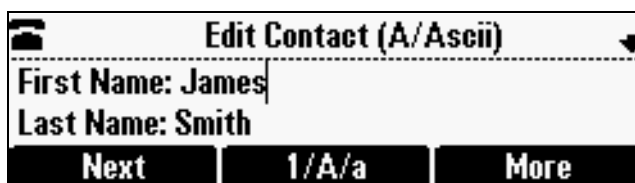

4. Use the **Next** and **Prev** soft keys to scroll to the **Watch Buddy** field, and then use the scroll keys or the **Change** soft key to choose **Enabled** or **Disabled**.

When Watch Buddy is enabled, the contact is added to your buddy list and you can monitor the contact's status. When Watch Buddy is disabled, the contact is removed from your buddy list and you cannot monitor the contact's status.

The default for Watch Buddy is Disabled.

5. Press the **Save** soft key.
6. Press  to return to the idle screen.

## Blocking Contacts From Viewing Your Status

Block a contact in your Contact Directory if you don't want the contact to view your status. If you unblock a contact, the contact can add you to their buddy list and view your status. You can also use your Blocked List to unblock contacts (see [Using Your Blocked List to Unblock Contacts](#) on page 4-5).

### Note

To view a list of contacts that can and cannot monitor your status, do the following:

- To view contacts that cannot view your status, press the **Menu** key, and then select **Features > Presence > Blocked List**.
- To view contacts that can view your status, press the **Menu** key, and then select **Features > Presence > Watcher List**.

### To block or unblock a contact:

1. Press , and then select **Features > Contact Directory**.

The Directory screen displays.



2. Scroll to the contact. Or, search for the contact (see [Searching for Contacts in Your Local Contact Directory](#) on page 2-19).

You can use the \* key to Page Up and the # key to Page Down.

3. Press the **Edit** soft key.

The Edit Contact screen displays.



4. Use the **Next** and **Prev** soft keys to scroll to the **Block Buddy** field, and then use the scroll keys or the **Change** soft key to choose **Enabled** or **Disabled**.

When Block Buddy is enabled, the contact cannot watch your phone. The contact will display in your Blocked List.

When Block Buddy is disabled, the contact can watch your phone. The contact will display in your Watcher List.

The default for Block Buddy is Disabled.

5. Press the **Save** soft key.
6. Press  to return to the idle screen.

### Using Your Blocked List to Unblock Contacts

Use the Blocked List to quickly unblock a contact, rather than updating the Block Buddy setting for the contact in your Contact Directory.

#### To use your Blocked List to unblock a contact:

1. Press , and then select **Features > Presence > Blocked List**.

The Blocked List screen displays.

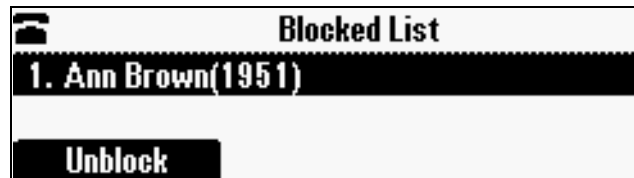

2. Scroll to the contact.
3. Press the **Unblock** soft key.
4. Press  to return to the idle screen.

The contact can now watch your phone. The contact will display in your Watcher List. (To view your Watcher List, press the **Menu** key, and then select **Features > Presence > Watcher List**.)

## Monitoring the Status of Contacts in Your Buddy List

You can monitor the status of all the contacts in your buddy list, except those contacts that have blocked you from viewing their status. (To add contacts to your buddy list, see [Selecting Contacts to Monitor](#) on page 4-3.)

### To monitor a contact in your buddy list:

>> Do one of the following:

- From the idle screen, press the **Buddies** soft key.

or

- Press , and then select **Features > Presence > Buddy Status**.

The Buddy Status screen displays, listing the status of all your buddies. From this screen, you can scroll to and dial the contact.

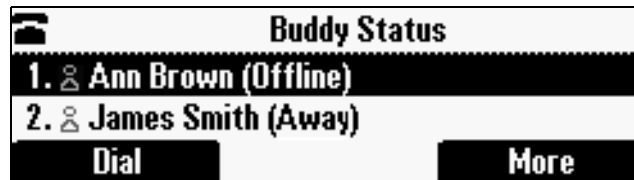



## Integrating With Microsoft Office Live Communications Server 2005

Your system administrator can configure your phone to work with Microsoft Office Live Communications Server 2005 and communicate with others using Microsoft Office Communicator and Windows Messenger. From your phone, you can invite, join, control, and monitor integrated multipoint conferences.

Any contact added through your buddy list will appear as a contact in Microsoft Office Communicator and Windows Messenger. Any contact added as a contact in Microsoft Office Communicator and Windows Messenger will appear in your buddy list. You can access your Privacy List on the phone to allow or disallow your contacts from monitoring your presence.

To view and change your presence, see [Updating Presence Settings](#) on page 4-2. For more information on integrating with Microsoft Office Live Communications Server 2005, contact your system administrator.

### To add a contact to your buddy list:

1. Press , and then select **Features > Presence > Buddy Status**.
2. Press the **Add** soft key.
3. Enter the phone number of the contact.
4. Press the **Submit** soft key.
5. Press  to return to the idle screen.

**To view and change your privacy list:**

1. Press , and then select **Features > Presence > Buddy Status > Privacy List**.
2. Scroll to the contact.
3. Press the **Edit** soft key.
4. Scroll to **Access**, and then use the scroll keys to select **Enabled**.

When Access is enabled, you allow the contact to see your presence. When Access is disabled, you prevent the contact from viewing your presence.

The default for Access is Disabled.

5. Press  to return to the idle screen.

For more information on contacting buddies, see the Microsoft Office Communicator and Windows Messenger documentation.

## Using Instant Messaging

**Note**

Instant Messaging is an optional feature that your system administrator enables. Your system may not support it. For more information, contact your system administrator.

You can send and receive instant messages using your phone. Your phone may indicate instant messages by the following:

- An icon, , on the phone screen
- A stutter dial tone instead of a normal dial tone

## Managing Instant Messages

From the Instant Messages screen, you can view instant messages, delete a message, or create a new message. Messages display in the order they are received (the first message received displays first).

### To manage instant messages:

1. Press , and then select **Features > Messages > Instant Messages**.
2. From the Instant Messages screen, you can do the following:
  - To view instant messages, press the **Next** or **Prev** soft keys to cycle through the messages in order.
  - To delete a message, press the **Next** or **Prev** soft keys to scroll to the message, and then press the **Delete** soft key.
  - To create a new message, press the **New** soft key. (See [Sending Instant Messages](#) on page 4-8.)

## Sending Instant Messages

### To send an instant message:

1. Press , and then select **Features > Messages > Instant Messages**.  
The Instant Messages screen displays.



2. Do one of the following:
  - To send a message, press the **New** soft key. Enter the desired phone number, and then press the **Ok** soft key. To enter a URL, press the **Name** soft key, enter the desired address, and then press the **Ok** soft key. (To enter a URL, see [Navigating Menus and Entering Data](#) on page 1-10.)or
  - To reply to a message, press the **Next** or **Prev** soft keys to select a message. Then, press the **Reply** soft key.



The Instant Messages screen displays. The phone number or URL you entered or selected displays on the screen.



3. Do one of the following:
  - To choose from various pre-scripted short messages, press the **Select** soft key. From the Message Select screen, scroll to the message you want.
  - or
  - To compose a custom message, press the **Edit** soft key. Then, enter your message. (To enter a message, see [Navigating Menus and Entering Data](#) on page 1-10.)
4. Press the **Send** soft key.
5. Press  to return to the idle screen.

## Restarting the Phone

### Note

If your phone malfunctions, you may be able to restore normal operation without restarting it. Before you restart your phone, contact your system administrator.

Periodically, you may need to restart your phone so your phone can:

- Accept a new configuration
- Accept new software

**To restart the phone:**

1. Press , and then select **Settings > Advanced**.

The Password screen displays.

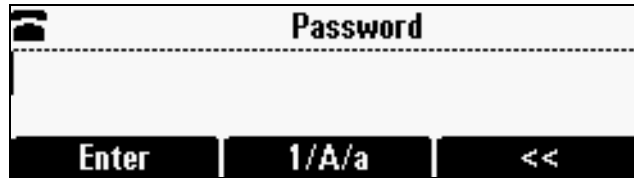

2. Enter your password, and then press the **Enter** soft key.

The Advanced screen displays.

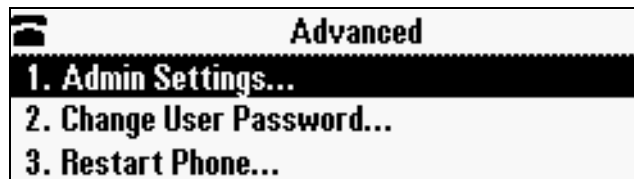

3. Select **Restart Phone**. A confirmation message displays. If you are sure you want to restart the phone, press the **Yes** soft key.

The restart process begins. The process ends when the idle screen displays.

# Troubleshooting Your Phone

This chapter contains general troubleshooting information to help you solve any problems you might encounter when you use the SoundStation IP 6000 conference phone. The tables in this chapter list possible trouble symptoms, the likely causes of these problems, and recommended corrective actions to take. Problems are grouped as follows:

- [Installation Configuration](#) on page 5-1
- [Power and Startup](#) on page 5-2
- [Controls](#) on page 5-3
- [Access to Screens and Systems](#) on page 5-4
- [Calling](#) on page 5-5
- [Displays](#) on page 5-6
- [Audio](#) on page 5-6

To obtain more detailed troubleshooting information, you can access certain menus on your phone that test your phone hardware. For more information, see [Testing Phone Hardware](#) on page 5-6.

If you require more information or assistance, contact your system administrator.

## Installation Configuration

Symptom	Problem	Corrective Action
The display shows: “General configuration error Unsupported configuration Undo last configuration change.”	The phone installation configuration is not supported.	Verify that you have installed the phone and any components correctly: <ul style="list-style-type: none"> <li>• See <a href="#">Installing the Phone</a> on page 1-2.</li> <li>• Check that no more than two microphones are installed.</li> <li>• Contact your system administrator.</li> </ul>

## Power and Startup

Symptom	Problem	Corrective Action
<p>The display shows “Network Link is Down.”</p>	<p>The network cable is not properly connected.</p>	<p>Verify that the network cable is properly connected:</p> <ul style="list-style-type: none"> <li>• Check the cable termination at the switch or hub (furthest end of the cable from the phone).</li> <li>• Check that the switch or hub is operational (flashing link/status lights).</li> <li>• Check if the LAN port is active or inactive. Press the <b>Menu</b> key, and then select <b>Status &gt; Network &gt; Ethernet</b>. From the Ethernet screen, scroll to <b>LAN port</b> and verify that it is Active.</li> </ul> <div data-bbox="1019 869 1414 978" style="border: 1px solid black; padding: 5px; margin: 10px 0;"> <p style="text-align: right; margin: 0;">Ethernet</p> <hr style="border-top: 1px dashed black;"/> <p>LAN port: Active            LAN Speed: 100Mbps            LAN Mode: Full-duplex</p> </div> <ul style="list-style-type: none"> <li>• Restart the phone to attempt re-registration with the call server. (See <a href="#">Restarting the Phone</a> on page 4-9.)</li> <li>• Contact your system administrator.</li> </ul>

## Controls

Symptom	Problem	Corrective Action
<p>The dial pad does not work.</p>	<p>The dial pad on the phone does not respond.</p>	<p>Do one of the following:</p> <ul style="list-style-type: none"> <li>• Check for a response from other feature keys or from the dial pad.</li> <li>• Place a call to the phone from a known working telephone. Check for display updates.</li> <li>• Check if the LAN port is active or inactive. Press the <b>Menu</b> key, and then select <b>Status &gt; Network &gt; Ethernet</b>. From the Ethernet screen, scroll to <b>LAN port</b> and verify that it is Active.</li> </ul> <div data-bbox="1019 810 1417 919" style="border: 1px solid black; padding: 5px; margin: 10px 0;"> <p style="text-align: right; margin: 0;"><b>Ethernet</b></p> <hr style="border-top: 1px dashed black; margin: 2px 0;"/> <p><b>LAN port: Active</b>  <b>LAN Speed: 100Mbps</b>  <b>LAN Mode: Full-duplex</b></p> </div> <ul style="list-style-type: none"> <li>• Check the termination at the switch or hub end of the network LAN cable. Ensure that the switch/hub port is operational (if it is not accessible, contact your system administrator).</li> <li>• Before restarting your phone, contact your system administrator. Your system administrator may want to troubleshoot the phone in more detail before restarting the phone and losing current status information.</li> </ul>

## Access to Screens and Systems

Symptom	Problem	Corrective Action
There is no response when you press a feature key.	The phone is not in an active state.	<p>Do one of the following:</p> <ul style="list-style-type: none"> <li>Press the keys more slowly.</li> <li>Call the phone to confirm that inbound call display and ringing is normal. If successful, try to press feature keys within the call to access the Directory or Buddy Status screens, for example.</li> <li>To confirm the line is actively registered to the call server, press the <b>Menu</b> key, and then select <b>Status &gt; Lines &gt; Line Information</b>. From the Line Information screen, verify that your phone line is registered.</li> </ul> <div data-bbox="1019 835 1414 940" style="border: 1px solid black; padding: 5px; margin: 10px 0;"> <p style="text-align: center;"><b>Line Information</b></p> <hr style="border-top: 1px dashed black;"/> <p><b>Line1: 1955 (Registered 25:40:35)</b>  <b>Server-1: r13as1:0</b></p> </div> <ul style="list-style-type: none"> <li>Restart the phone to attempt re-registration with the call server. (See <a href="#">Restarting the Phone</a> on page 4-9.)</li> </ul>
The display shows “Network Link is Down.”	The network cable is not properly connected.	See <a href="#">Power and Startup</a> on page 5-2.

# Calling

Symptom	Problem	Corrective Action
There is no dial tone.	Power is not correctly applied to the phone.	<p>Verify that power is correctly applied to the phone:</p> <ul style="list-style-type: none"> <li>• Check that the display is illuminated.</li> <li>• Ensure the network cable is inserted properly on the underside of the phone. (Try unplugging and re-inserting the cable.)</li> </ul>
There is no audible ring tone.	Ringer volume is low, or the Ring Type is set to Silent Ring.	<p>Verify ringer volume and Ring Type:</p> <ul style="list-style-type: none"> <li>• To adjust the ringer volume, press either the volume up or volume down key when the phone is in the idle state.</li> <li>• Check that the Ring Type is not set to Silent Ring. (See <a href="#">Updating the Ring Tone</a> on page 2-9.)</li> </ul>
	Outbound or inbound calling is unsuccessful.	Place a call to the phone under investigation. Check that the display indicates incoming call information.
<p>A “hollow” phone icon displays at the top left of the screen.</p> 	The phone is not registered to a server.	Ask your system administrator to register the phone to a server.

## Displays

Symptom	Problem	Corrective Action
There is no display. The display is incorrect. The display has bad contrast.	Power is not correctly applied to the phone.	Verify that power is correctly applied to the phone: <ul style="list-style-type: none"> <li>• Check that the display is illuminated.</li> <li>• Ensure the network cable is inserted properly on the underside of the phone. (Try unplugging and re-inserting the cable.)</li> <li>• If your phone uses Power over Ethernet (PoE), have your system administrator check that the switch is supplying power to the phone.</li> </ul>
	The contrast needs adjustment.	Adjust the screen contrast. (See <a href="#">Updating the Display Contrast</a> on page 2-6.)
The display is flickering.	Certain types of older fluorescent lighting cause the display to appear to flicker.	Try the following: <ul style="list-style-type: none"> <li>• Move the phone away from the lights.</li> <li>• Replace the lights.</li> </ul>

## Audio

Symptom	Problem	Corrective Action
The speaker has no audible sound.	Speaker volume is low.	Adjust the speaker volume. During a call, press either the volume up or volume down key.

## Testing Phone Hardware

Your system administrator may ask you to access a diagnostics menu on your phone to test your phone hardware. From the diagnostics menu, you can test your phone's microphones, keypad mappings, and display. See your system administrator for instructions on how to perform these tests.

### To access the diagnostics menus:

>> Press , and then select **Status > Diagnostics > Test Hardware > Audio Diagnostics, Keypad Diagnostics, or Display Diagnostics.**



# Safety Notices

---

## Service Agreements

Please contact your Polycom Authorized Reseller for information about service agreements applicable to your product.

## Governing Law

This Limited Warranty and Limitation of Liability shall be governed by the laws of the State of California, U.S.A., and by the laws of the United States, excluding their conflicts of laws principles. The United Nations Convention on Contracts for the International Sale of Goods is hereby excluded in its entirety from application to this Limited Warranty and Limitation of Liability.

All rights reserved under International and Pan-American Copyright Conventions. No part of the contents of this manual may be copied, reproduced, or transmitted in any form or by any means, or translated into another language or format, in whole or part, without written consent from Polycom, Inc. Do not remove (or allow anybody else to remove) any product identification, copyright or other notices.

## Limitations of Liability

LIMITATION OF LIABILITY. TO THE FULL EXTENT ALLOWED BY LAW, POLYCOM EXCLUDES FOR ITSELF AND ITS SUPPLIERS ANY LIABILITY, WHETHER BASED IN CONTRACT OR TORT (INCLUDING NEGLIGENCE), FOR INCIDENTAL, CONSEQUENTIAL, INDIRECT, SPECIAL, OR PUNITIVE DAMAGES OF ANY KIND, OR FOR LOSS OF REVENUE OR PROFITS, LOSS OF BUSINESS, LOSS OF INFORMATION OR DATA, OR OTHER FINANCIAL LOSS ARISING OUT OF OR IN CONNECTION WITH THE SALE, INSTALLATION, MAINTENANCE, USE, PERFORMANCE, FAILURE, OR INTERRUPTION OF ITS PRODUCTS, EVEN IF POLYCOM OR ITS AUTHORIZED RESELLER HAS BEEN ADVISED OF THE POSSIBILITY OF SUCH DAMAGES, AND LIMITS ITS LIABILITY TO REPAIR, REPLACEMENT, OR REFUND OF THE PURCHASE PRICE PAID, AT POLYCOM'S OPTION. THIS DISCLAIMER OF LIABILITY FOR DAMAGES WILL NOT BE AFFECTED IF ANY REMEDY PROVIDED HEREIN SHALL FAIL OF ITS ESSENTIAL PURPOSE.

### **Polycom Limited Warranty and Limitation Liability**

LIMITED WARRANTY. Polycom warrants to the end user (“Customer”) that this product is expected to be free from defects in workmanship and materials, under normal use and service, for one year from the date of purchase from Polycom or its authorized reseller.

Polycom’s sole obligation under this express warranty is at Polycom’s option and expense, to repair the defective product or part, deliver to Customer an equivalent product or part to replace the defective item, or if neither of the two foregoing options are reasonably available, Polycom may, on its sole discretion, refund to Customer the purchase price paid for the defective product. All products that are replaced will become the property of Polycom. Replacement products or parts may be new or reconditioned.

Polycom is expected to warrant any replaced or repaired product or part for ninety (90) days from shipment, or the remainder of the initial warranty period, whichever is longer. Products returned to Polycom must be sent prepaid and packaged appropriately for safe shipment, and it is recommended that they be insured or sent by a method that provides for tracking of the package. Responsibility for loss or damage does not transfer to Polycom until the returned item is received by Polycom. The repaired or replaced item will be shipped to Customer, at Polycom’s expense, not later than thirty (30) days after Polycom receives the defective product, and Polycom will retain risk of loss or damage until the item is delivered to Customer.

### **Exclusions**

Polycom will not be liable under this limited warranty if its testing and examination disclose that the alleged defect or malfunction in the product does not exist or results from:

- Failure to follow Polycom’s installation, operation, or maintenance instructions.
- Unauthorized product modification or alteration.
- Unauthorized use of common carrier communication services accessed through the product.
- Abuse, misuse, negligent acts or omissions of Customer and persons under Customer’s control; or
- Acts of third parties, acts of God, accident, fire, lightening, power surges or outages, or other hazards.

### **Warranty Exclusive**

IF A POLYCOM PRODUCT DOES NOT OPERATE AS WARRANTED ABOVE, CUSTOMER’S SOLE REMEDY FOR BREACH OF THAT WARRANTY SHALL BE REPAIR, REPLACEMENT, OR REFUND OF THE PURCHASE PRICE PAID, AT POLYCOM’S OPTION. TO THE FULL EXTENT ALLOWED BY LAW, THE FOREGOING WARRANTIES AND REMEDIES ARE EXCLUSIVE AND ARE IN LIEU OF ALL OTHER WARRANTIES, TERMS, OR CONDITIONS, EXPRESS OR IMPLIED, EITHER IN FACT OR BY OPERATION OF LAW, STATUTORY OR OTHERWISE, INCLUDING WARRANTIES, TERMS, OR CONDITIONS OF MERCHANTABILITY, FITNESS FOR A PARTICULAR PURPOSE, SATISFACTORY QUALITY, CORRESPONDENCE WITH DESCRIPTION, AND NON-INFRINGEMENT, ALL OF WHICH ARE EXPRESSLY DISCLAIMED. POLYCOM NEITHER ASSUMES NOR AUTHORIZES ANY OTHER PERSON TO ASSUME FOR IT ANY OTHER LIABILITY IN CONNECTION WITH THE SALE, INSTALLATION, MAINTENANCE OR USE OF ITS PRODUCTS.

**Safety and Compliance****Part 15 FCC Rules**

This device is compliant with Part 15 of the FCC Rules. Operation is subject to the following two conditions:

1. This device may not cause harmful interference, and
2. This device must accept any interferences received, including interference that may cause undesired operation.

**Class A Digital Device or Peripheral**

Note: This equipment has been tested and found to comply with the limits for a Class A digital device, pursuant to part 15 of the FCC Rules. These limits are designed to provide reasonable protection against harmful interference when the equipment is operated in a commercial environment. This equipment generates, uses, and can radiate radio frequency energy and, if not installed and used in accordance with the instruction manual, may cause harmful interference to radio communications. Operation of this equipment in a residential area is likely to cause harmful interference in which case the user will be required to correct the interference at his own expense.

**Modifications**

In accordance with Part 15 of the FCC Rules, the user is cautioned that any changes or modifications not expressly approved by Polycom, Inc. could void the user's authority to operate the equipment. This equipment may not be used on a coin service or party line.

**Installation Instructions**

Installation must be performed in accordance with all relevant national wiring rules.

L'Installation doit être exécutée conformément à tous les règlements nationaux applicable au filage électrique.

**Plugs Acts as Disconnect Device**

The socket outlet to which this apparatus is connected must be installed near the equipment and must always be readily accessible.

La prise électrique à laquelle l'appareil est branché doit être installée près de l'équipement et doit toujours être facilement accessible.

**Industry Canada (IC)**

This Class [A] digital apparatus complies with Canadian ICES-003.

Cet appareil numérique de la classe [A] est conforme à la norme NMB-003 du Canada.

**CE and VCCI Mark**

This SoundStation IP 6000 phone is marked with the CE mark. This mark indicates compliance with EC Directives 2006/95/ED and 2004/108/EC. A full copy of the Declaration of Conformity can be obtained from Polycom Ltd., 270 Bath Road, Slough, Berkshire, SL1 4DX, UK.

この装置は、クラスA 情報技術装置です。この装置を家庭環境で使用すると電波妨害を引き起こすことがあります。この場合には使用者が適切な対策を講ずるよう要求されることがあります。 VCCI- A

**Safety and Compliance (continued)**

사용자 안내문

A 급기기(업무용 정보통신기기)

이 기기는 업무용으로 전자파적합등록을 한 기기이오니 판매자 또는 사용자는 이 점을 주의하시기 바라며 만약 잘못 판매 또는 구입하였을 때에는 가정용으로 교환하시기 바랍니다.

**WARNING Electrical Safety**

To avoid electric shock, do not connect safety extra low voltage (SELV) circuits to teleconference station network (TNV) circuits. LAN ports contain SELV circuit, and WAN ports contain TNV circuits. Some LAN and WAN ports both use RJ-45 connectors. Use caution when connecting cables.

This product is rated 48Vdc, 0.375A. When used with the optional external power supply, the power supply shall be a Listed power supply with a LPS output, rated 48V, min. 0.375A.

# Index

## Symbols

# key, page down shortcut 1-10

\* key, page up shortcut 1-10

## Numerics

1/A/a soft key 1-10

## A

AC power kit 1-2

AC power, using 1-4

accessories, for phone 1-2

addresses, entering 1-10

answering calls 3-4

attended transfer, about 3-9

Audio Diagnostics menu 5-6

audio problems, troubleshooting 5-6

auto divert setting 2-16, 2-25

auto reject setting 2-16, 2-24

## B

backlight intensity, updating 2-6

Blind soft key 3-10

blind transfer 3-9, 3-10

block buddy setting 2-16, 4-5

Blocked List 4-4, 4-5

blocking and unblocking contacts 4-4

Buddies soft key 4-6

buddies, managing 4-2

buddy list, viewing 4-6

Buddy Status screen 4-2

## C

call

appearances 4-1

forwarding 3-11

icons 1-9

key, about 1-8

lists, using 2-11

calling problems, troubleshooting 5-5

calls

answering 3-4

and call lists 2-11

dialing using speed dials 3-2, 3-3

dialing using URLs 3-2

distinguishing by ring type 2-23

diverting 2-25

ending 3-4

forwarding 3-11

holding 3-6

ignoring 3-4

placing 3-2

redialing 3-5

rejecting 2-23, 3-4

resuming 3-6

transferring 2-25, 3-9

types of 3-2

characters, entering 1-10

clearing call list entries 2-13

clock order, changing 2-5

conference calls

about 3-6

ending 3-9

holding 3-8

setting up 3-7

setting up with Join soft key 3-8

splitting 3-9

conference phone. *See* SoundStation IP 6000

Confrnc soft key 3-7

Connect soft key 3-17

consultative transfer 3-9

Contact Directory

about 2-13

adding contacts to 2-14

deleting contacts from 2-22

managing 2-13

placing calls to contacts in 2-22

searching for contacts in 2-19

storing contacts in 2-13

updating contacts in 2-20

viewing contacts in 2-13

contacts

- adding to Contact Directory 2-14
- blocking and unblocking 4-4
- calling 2-22, 2-23
- deleting 2-22
- managing 2-13
- saving from Corporate Directory 2-18
- searching for in Contact Directory 2-19
- searching for in Corporate Directory 2-20
- setting ring types for 2-10
- storing in Contact Directory 2-13
- unblocking 4-5
- updating 2-20
- viewing in Contact Directory 2-13
- viewing in Corporate Directory 2-14

contrast, updating 2-6

Corporate Directory

- about 2-13
- placing calls to contacts in 2-23
- and Retain Search feature 2-20
- saving contact to Contact Directory 2-18
- searching for contacts in 2-20
- viewing contacts in 2-14

customizing your phone 2-1

**D**

- data, entering 1-10
- date and time display, updating 2-3
- date and time, updating 2-5
- deleting text 1-11
- Diagnostics Menu, accessing 5-6
- dial pad keys, about 1-8
- dialing, using URLs 3-2
- dim mode intensity 2-7
- directory contacts, managing 2-13
- display contrast, updating 2-6
- Display Diagnostics menu 5-6
- display problems, troubleshooting 5-6
- divert contact setting 2-16, 2-25
- diverting calls 2-25
- Do Not Disturb feature 3-4, 3-14
- dynamic forwarding 3-13

**E**

- Encoding soft key 1-11
- ending calls 3-4, 3-9
- exit key, about 1-8
- extension microphones 1-2, 1-5
- external microphone kit 1-2

**F**

- fields, enabling and disabling 1-11
- forwarding calls 3-11

**H**

- hardware, troubleshooting 5-6
- HD Voice, description of 1-9
- holding calls 3-6, 3-8

**I**

- ignoring calls 3-4
- installation instructions 1-1
- installation issues, troubleshooting 5-1
- installing phone
  - using AC power 1-4
  - with extension microphones 1-5
  - using PoE 1-3
- instant messaging, using 4-7
- IP addresses, entering 1-10

**J**

- Join soft key 3-7, 3-8

**K**

- key buttons, identifying 1-7
- Keypad Diagnostics menu 5-6
- keypad mappings, testing 5-6

**L**

- LAN port, checking status of 5-2
- language, selecting for text 1-11
- language, updating for phone 2-2
- Last Call Return feature 3-2
- LCR feature 3-2
- LED indicators, about 1-6
- letters, entering 1-10
- line and call icons 1-9
- line information, checking 5-4
- lowercase characters, entering 1-10

**M**

- maximum intensity, about 2-6
- menu key, about 1-8
- menus, navigating 1-10
- messages, accessing 3-17, 4-8
- microphone, muting 3-5
- microphones, internal, about 1-6

microphones, testing 5-6  
Microsoft Office Live Communications  
  Server 2005 4-2, 4-6  
missed calls list 2-11  
multiple call appearances 4-1  
mute key, about 1-7  
muting the microphone 3-5  
MyStat soft key 4-2

## N

navigation keys, using 1-10  
network cable 1-2  
network, connecting phone to 1-3  
numbers, entering 1-10

## O

off-hook dialing, about 3-2  
on-hook dialing, about 3-2  
optional accessories for phone 1-2

## P

parts list for phone 1-2  
phone controls, troubleshooting 5-3  
phone hardware, testing 5-6  
placed calls list 2-11  
placing calls 3-2  
PoE, using 1-3  
power adapter 1-2, 1-4  
power insertion cable 1-2, 1-4  
power issues, troubleshooting 5-2  
Power over Ethernet 1-3  
power source, connecting to phone 1-3  
Preferences menu, about 2-2  
presence settings 4-2  
privacy list, updating 4-7

## R

received calls list 2-11  
records, clearing in call lists 2-12, 2-13  
redial key, about 1-8  
redialing numbers 3-5  
Regional Power Cord 1-2  
registered line, description of 1-9  
registration status of phone 5-4  
Reject feature 3-4  
rejecting calls 2-23  
restarting the phone 2-12, 4-9

Resume soft key 3-4, 3-6  
resuming calls 3-6, 3-8  
Retain Search feature 2-20  
ring tones  
  and associated number 2-10  
  selecting 2-9  
  setting for contacts 2-10, 2-23  
ringer volume, adjusting 2-11

## S

scroll keys, about 1-7  
select key, about 1-7  
shared lines  
  about 2-26  
  answering calls on 3-4  
  and call forwarding 2-26  
  ignoring calls on 3-4  
  and rejecting calls 2-23  
  and the Silence feature 3-4  
silent ring, answering calls with 3-4  
soft keys, about 1-8  
SoundStation IP 6000  
  accessories for 1-2  
  customizing 2-1  
  features, list of 1-6  
  figure of 1-6, 1-7  
  hardware, testing 5-6  
  icons for 1-9  
  installing 1-1  
  key buttons, list of 1-7  
  language support for 2-2  
  menus, navigating 1-10  
  package contents 1-2  
  parts list for 1-2  
  restarting 4-9  
  settings, configuring 2-2  
  troubleshooting 5-1  
speaker 1-6, 2-11  
special characters, entering 1-10  
speed dialing 3-3, 3-15  
Split soft key 3-8, 3-9  
splitting conference calls 3-9  
startup issues, troubleshooting 5-2  
static forwarding 3-11  
status settings, updating 4-2

## T

testing phone hardware 5-6  
text, deleting 1-11  
text, entering 1-10

time and date display, updating 2-3  
time and date, updating 2-5  
transferring calls 3-9  
troubleshooting phone issues 5-1

## **U**

Unblock soft key 4-5  
unregistered line, description of 1-9, 5-5  
uppercase characters, entering 1-10  
URLs, entering 1-10  
URLs, using to dial 3-2

## **V**

voice mail, using 2-23, 3-16  
volume keys 1-7  
volume, adjusting 1-7, 2-11

## **W**

watch buddy setting 2-16, 4-4  
Watcher List 4-4, 4-5